

2-SERIES MINI PUMP

MAGNETIC-DRIVE, CLOSE-COUPLED GEAR PUMP



Models 2R & 2F

Table of Contents

	Introduction	2
Section 1:	General Information	3-6
Section 2:	Safety Precautions	7
Section 3:	Pump & Motor Installation	8-10
Section 4:	Start-Up & Operation	11
Section 5:	Maintenance & Repair	12-20
	Appendix	21-27

Introduction

This manual provides instructions for the installation, operation and maintenance of the Liquiflo 2-Series Gear Pumps, Models 2R and 2F. It is critical for any user to read and understand the information in this manual along with any documents this manual refers to prior to installation and start-up.

Liquiflo shall not be liable for damage or delays caused by a failure to follow the instructions for installation, operation and maintenance as outlined in this manual.

Thank you for purchasing a Liquiflo product.

LIQIFLO STANDARD TERMS AND CONDITIONS APPLY UNLESS SPECIFIED IN WRITING BY LIQIFLO.

Detailed Table of Contents

<p>1. General Information</p> <p> 1.1 General Instructions 3</p> <p> 1.2 Pump Specifications 4</p> <p> 1.3 Model Coding 5</p> <p> 1.4 Repair Kits & Replacement Parts 6</p> <p> 1.5 Returned Merchandise Authorization (RMA) .. 6</p> <p>2. Safety Precautions</p> <p> 2.1 General Precautions 7</p> <p> 2.2 Precautions for Magnetic-Drive Pumps 7</p> <p>3. Pump & Motor Installation</p> <p> 3.1 Installation of Pump, Motor and Base 8</p> <p> 3.2 General Piping Requirements 8</p> <p> 3.3 Gear Pump Requirements 9</p> <p> 3.4 General Motor Requirements 9-10</p> <p> 3.4.1 Motor Selection 9</p> <p> 3.4.2 Motor Hook-Up 10</p> <p> 3.4.3 Motor Direction 10</p> <p>4. Start-Up & Operation</p> <p> 4.1 Precautions Prior to Starting Pump 11</p> <p> 4.2 Operating Requirements 11</p> <p> 4.3 Troubleshooting 11</p>	<p>5. Maintenance & Repair</p> <p> 5.1 Work Safety 12</p> <p> 5.2 Removal from System 12</p> <p> 5.3 Pump Disassembly 13-14</p> <p> Removal of Pump from Motor 13</p> <p> Removal of Containment Can & Inner Magnet 13-14</p> <p> Removal of Internal Parts 14</p> <p> Removal of Outer Magnet 14</p> <p> 5.4 Pump Assembly 15-20</p> <p> Bearing-Wear Plate Installation ... 15-16</p> <p> Installation of Gear-Shafts 16</p> <p> Installation of Wave Springs 17</p> <p> Installation of Inner Magnet 18</p> <p> Installation of Containment Can & Mounting Bracket 18</p> <p> Installation of Outer Magnet 19-20</p> <p> Installation of Pump to Motor 20</p> <p>Appendix:</p> <p>A-1: Fastener Torque Specifications 21</p> <p>A-2: Pump Bill of Materials (BOM) 22</p> <p>A-3: Reference Drawings 23-25</p> <p>A-4: Troubleshooting Guide 26-27</p>
--	---

Section 1: General Information

1.1 General Instructions

This manual covers the 2-Series Mag-Drive, Close-Coupled Gear Pumps – Models 2R and 2F.

The materials of construction of the pump are selected based upon the chemical compatibility of the fluid being pumped. The user must verify that the materials are suitable for the surrounding atmosphere.

If the fluid is non-conductive, methods are available to mechanically ground the isolated shaft. This is only necessary if the surrounding atmosphere is extremely explosive or stray static charges are present.

Upon receipt of your Liquiflo pump:

- A) Verify that the equipment has not been damaged in transit.
- B) Verify that the *Liquiflo Stainless Steel Nameplate* is attached to the pump's mounting bracket. The nameplate displays the pump *Model Number* and *Serial Number*, positioned as shown.
- C) Verify that the Model Number on the nameplate matches the Model Number that was ordered.
- D) For ATEX certification, verify that the following *Stainless Steel Tag* is attached to the pump:



Explanation of ATEX Tag	
Group II	Explosive atmospheres
Category 2	Equipment provides a high level of protection. Explosive atmospheres are likely to occur.
Category 3	Equipment provides a normal level of protection. Explosive atmospheres are unlikely to occur.
D	Dust
G	Gas

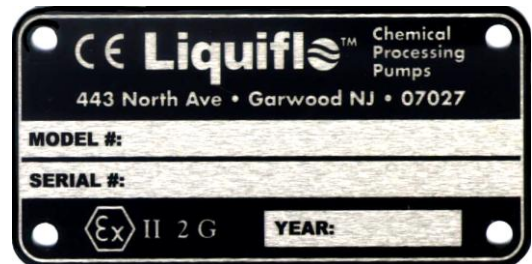

- E) Record the following information for future reference:

Model Number:
Serial Number:
Date Received:
Pump Location:
Pump Service:

NOTE: By adding a **K** prior to the pump's Model Code, a **Repair Kit** can be obtained which consists of the following parts: drive and idler gear-shaft assemblies, bearing-wear plates, wave springs, housing alignment pins and O-rings (see **Appendix 2** for more information).

1.2 Pump Specifications

Table 1: 2-Series Gear Pump Specifications

Pump Model		2R	2F	Units
Ports	Size	1/4	1/4	in
	Type	Threaded (NPT or BSPT)		-
Pump Body Material		316 Stainless Steel		-
Gears, Bearing-Wear Plates & Shafts		See Table 2 (Page 5) for Material Data		-
O-Ring Material		Teflon (PTFE), Viton or Kalrez		-
Mounting Bracket	Material	Cast Iron, Epoxy Painted		-
	Motor Frames	NEMA 48C, IEC 71 (B14 Face) & NEMA 56C ⁵		-
Magnetic Coupling	Materials	Magnets: Samarium Cobalt (SmCo) Inner Magnet Casing: 316 Stainless Steel Outer Magnet Casing: Carbon Steel/Epoxy		-
	Size (Max Torque)	MCX (10)	MCX (10)	in-lbs
Maximum Speed		1750	1750	RPM
Theoretical Displacement ¹		.0001385	.000277	GPR
		.0005243	.001049	LPR
Maximum Flow Rate		0.24	0.48	GPM
		0.92	1.84	LPM
		14.5	29.1	GPH
		55	110	LPH
Maximum Differential Pressure ²		225	225	PSI
		15.5	15.5	bar
Maximum System Pressure		300	300	PSI (g)
		20.7	20.7	bar (g)
Maximum Temperature		500	500	°F
		260	260	°C
Minimum Temperature		-40	-40	°F
		-40	-40	°C
Maximum Viscosity (300 RPM)		5,000	5,000	cP
		5,000	5,000	mPas
NPSHR ³		2	2	ft
		0.6	0.6	m
Suction Lift (dry) ³		1.2	1.2	ft
		0.4	0.4	m
Weight ⁴		5	5	lbs
		2.3	2.3	kg

FOOTNOTES:

- 1 Based on new pump operating at Maximum Speed and 0 PSI (bar) differential pressure.
- 2 Maximum Differential Pressure is derated to 125 PSI (8.6 bar) for fluid viscosities < 10 cP.
- 3 Net Positive Suction Head Required and Suction Lift are specified at Maximum Speed and 1 cP (mPas).
- 4 Approximate weight, excluding motor.
- 5 Adapter plate is required for NEMA 56C motor frames (see Page 19).

NOTES:

- 1 The actual maximum surface temperature depends not on the pump but primarily on the temperature of the fluid being pumped. Temperature class can be controlled with the use of thermal sensors. Pump surfaces will be approximately 20 °F (7 °C) above the temperature of the fluid being pumped.
- 2 Pump is designed to operate within the ambient temperature range of -4 °F (-20 °C) to 104 °F (40 °C).

1.3 Model Coding

Table 2: Model Coding for 2-Series Gear Pumps

Position	Description	Code	Selection
1	Pump Model	2	2-Series Pump
2	Pump Model	F	Full Capacity (Model 2F)
		R	Reduced Capacity (Model 2R)
3	Housing Material & Port Type	S	316 SS Housing & NPT Ports
		X	316 SS Housing & BSPT Ports
4	Drive Gear	1	Alloy-C
		6	316 SS
		P	PEEK
5	Idler Gear	1	Alloy-C
		6	316 SS
		P	PEEK
6	Bearing - Wear Plates	E	Carbon-60
		P	PEEK
7	Outer Magnet Bore (Motor Frame)	0	1/2 in. (NEMA 48C)
		1	14 mm (IEC 71 - B14 Face)
		2	5/8 in. (NEMA 56C)
8	Shafts	0	316 SS, Uncoated
		1	Chrome Oxide Coated 316 SS
		2	Tungsten Carbide Coated 316 SS
9	O-rings	0	Teflon
		V	Viton
		K	Kalrez
10	Magnetic Coupling	X	MCX (10 in-lbs)
Suffix	Trim Option		No Trim
		- 8(T)*	Temperature Trim

* T = Application Temperature in °F (Example: - 8(300) = Temperature Trim at 300°F).

Model Coding Example:

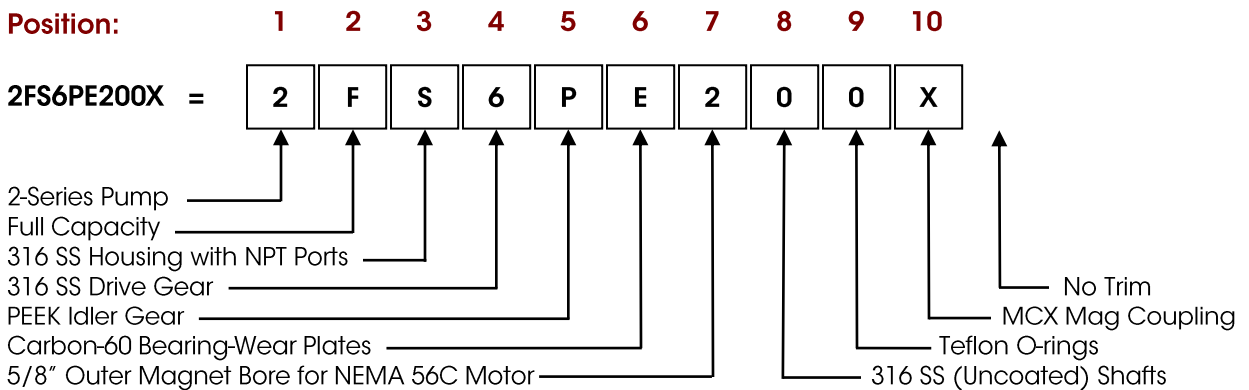

1.4 Repair Kits & Replacement Parts

Repair kits and replacement parts for the pumps can be purchased from your local Liquiflo distributor. Refer to **Appendices 2 and 3** for individual parts information.

1.5 Returned Merchandise Authorization (RMA)

If it is necessary to return the pump to the factory for service,

- 1) Contact your local Liquiflo distributor to discuss the return, obtain a Returned Merchandise Authorization Number (**RMA #**) and provide the distributor with the required information (see RMA Record below).
- 2) Clean and neutralize pump.
- 3) Package the pump carefully and include the **RMA #** in a visible location on the outside surface of the box.
- 4) Ship pump to factory, freight prepaid.

Returned Merchandise Authorization (RMA) Record		
1	RMA #	(Supplied by Distributor)
2	Distributor Name	
3	Order Date	
4	Customer PO #	
5	Return Date	
6	Item(s) Returned	
7	Serial Number(s)	
8	Reason for Return	
9	Fluid(s) Pumped	
10	Notes	

NOTE: Pump must be cleaned and neutralized prior to shipment to the factory.

Section 2: Safety Precautions

2.1 General Precautions

- **Always** lock out the power to the pump driver when performing maintenance on the pump
- **Always** lock out the suction and discharge valves when performing maintenance on the pump
- **Never** operate the pump without safety devices installed
- **Never** operate the pump with suction and/or discharge valves closed
- **Never** operate the pump out of its design specifications
- **Never** start the pump without making sure that the pump is primed
- **Never** use heat to disassemble the pump
- Inspect the entire system before start-up
- Monitor the system during operation and perform maintenance periodically or as required by the application
- Decontaminate pump using procedures in accordance with federal, state, local and company environmental regulations
- Before performing maintenance on the pump, check with appropriate personnel to determine if skin, eye or lung protection is required and how best to flush the pump
- When performing maintenance, pay special attention to all cautionary statements given in this manual.

**Caution!**

Failure to observe safety precautions can result in personal injury, equipment damage or malfunction.

2.2 Precautions for Magnetic-Drive Pumps

Magnetic-drive pumps contain strong magnets, which pose health risks. Based on this the following must be observed:

**Caution!**

- *Individuals with cardiac pacemakers should avoid repairs on these units*
- *Individuals with internal wound clips, metallic wiring, or other metallic prosthetic devices should avoid repairs on these units*
- *Strong magnetic fields can cause tools and parts to slam together, injuring hands and fingers*

Strong magnets will attract iron, cast iron, carbon steel and some types of stainless steel. Keep magnets away from credit cards, computers, computer discs and watches.

Section 3: Pump & Motor Installation

3.1 Installation of Pump, Motor & Base

Refer to the Hydraulic Institute Standards for proper installation procedures of the base, pump and motor. Observe the following guidelines:

- 1) The foundation area must be rigid and level for maintaining pump alignment.
- 2) The pump and motor assembly must be securely fastened to the base, and the base must be securely attached to the ground.
- 3) The pump inlet should be as close to the liquid source as practical and preferably below it.
- 4) The pump and motor should be accessible for servicing and inspection.
- 5) The pump and motor should be protected from dust or cleaned periodically to prevent the build-up of dust.

NOTE: The 2-Series pumps are close-coupled and no alignment procedure between the pump and motor is required.

3.2 General Piping Requirements

Guidelines for piping are given in the Hydraulic Institute Standards and should be reviewed prior to pump installation.

- 1) All piping must be supported independently and must line up naturally with pump ports.



Caution!

Do not use the pump to support the piping or allow the piping to apply stress to the pump ports. This can distort the alignment of the pump housing with internal parts and lead to rapid wear or malfunction.

- 2) DO NOT make final connection of piping to pump until the base has been secured and the motor mounting bolts have been tightened.
- 3) Piping that handles both hot and cold liquids require proper installation of expansion loops and joints so that thermal expansion of the piping will not cause misalignment.
- 4) Piping runs should be designed to minimize friction losses.
- 5) Suction and discharge piping should be the same size or larger than the inlet and outlet ports.
- 6) The piping should be arranged to allow the pump to be flushed and drained prior to the removal of the pump for servicing. Valves and unions should be installed to allow the pump to be isolated during maintenance.
- 7) The piping system should be thoroughly cleaned prior to installation of the pump.

3.3 Gear Pump Requirements

- 1) A positive displacement pump should have a **pressure relief valve** installed in the discharge line. Install the relief valve between the pump discharge port and the discharge isolation valve. The relief valve should bypass the discharge line back to the supply tank, not back to the pump suction port. This is to prevent the pump from overheating should it be left running in a relieved condition.
- 2) The maximum particle size capable of being passed by the pumps is 37 microns. When pumping fluids containing suspended solids, a **filter** of at least 400 U.S. Mesh should be installed in the suction line.
- 3) Concentration of solids should be limited to 1% by volume. Exceeding this concentration can cause the wear rate to increase to an unacceptable level, resulting in a rapid decrease in pump performance. In addition to solids concentration, the specific wear rate also depends on the size, shape and hardness of the particles, the operating speed and the materials used to construct the pump.

3.4 General Motor Requirements

- 1) The motor must be compatible with the pump and conditions of the application.
- 2) The motor supply voltage must match the nameplate voltage of the motor.
- 3) The motor should never be operated outside of its design specifications.
- 4) The motor should be inspected periodically and serviced or replaced as required.

**Caution!**

Lock out power to the motor before servicing or replacing.

3.4.1 Motor Selection

- 1) The motor frame must be equipped with feet for mounting to a base (see cover photo).
- 2) The motor frame must be compatible with the pump mounting bracket. Choices are NEMA 48C, 56C and IEC 71 (with B14 Face). NEMA 56C motor frames will require an *adapter plate* and four *adapter mounting bolts* with *lockwashers* to mount the bracket to the motor. (Note: Complete pumps ordered for use with NEMA 56C motor frames will be supplied with the adapter plate and mounting hardware; see **Appendix 2** for Part Numbers.)
- 3) The motor must have an enclosure that is compatible with the application conditions. If an explosion-proof motor is required, the *temperature code* of the motor must be acceptable for the fluid that will be pumped.
- 4) The speed and power output rating of the motor must be sufficient for the conditions of service. The *power output rating* of the motor should exceed the maximum power that will be required by the pump over its operating range.

3.4.2 Motor Hook-Up

- 1) Electrical wiring of the motor should be performed by a certified electrician.
- 2) Follow the recommendations of the motor manufacturer and observe all electrical wiring safety standards.
- 3) The motor supply voltage must match the motor nameplate voltage or serious motor damage or fire can result.



Caution!
Lock out power to the motor before connecting to power line.

3.4.3 Motor Direction

The motor shaft is magnetically coupled to the drive shaft of the pump. Both shafts will turn in the same direction. Because the gear pump is bi-directional, the pump shaft can turn in either direction to produce flow in either direction. The direction of rotation of the motor shaft (same as that of the pump drive shaft) will determine which side of the pump is the *inlet* (suction side) and which side is the *outlet* (discharge side). For the 2-Series pumps, the flow direction will be as shown below:

Top View of 2-Series Mag-Drive Gear Pump (with Transparent Bracket) Close-Coupled to Motor

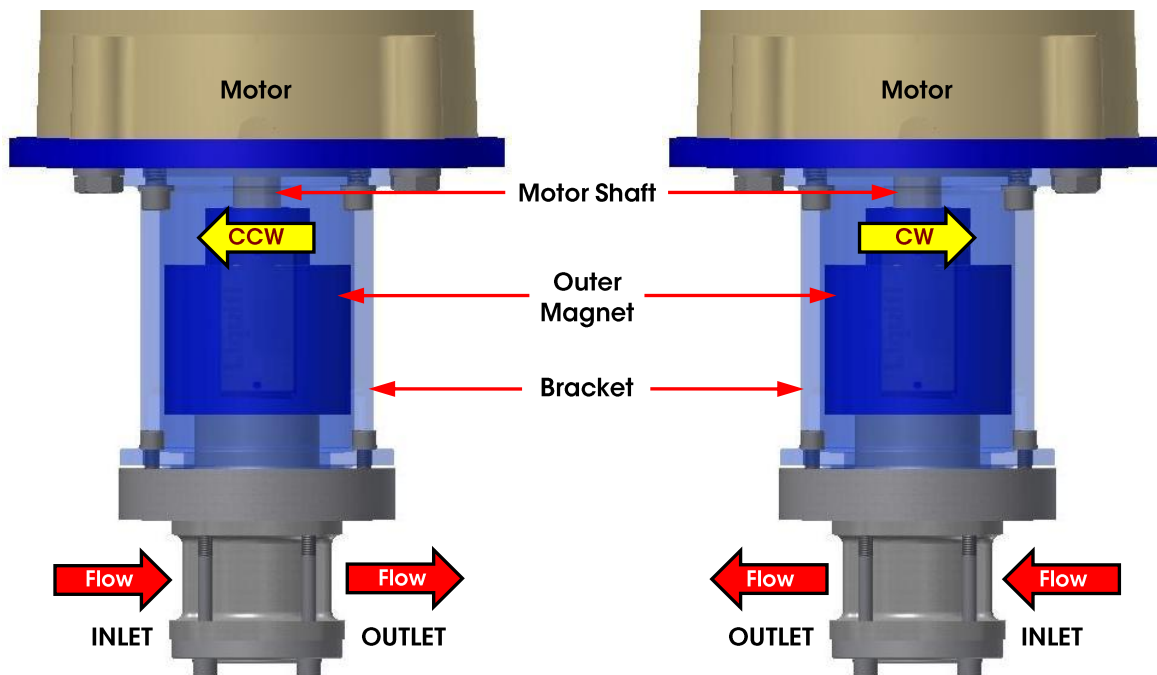

Counterclockwise (CCW) Rotation of Motor Shaft:

Fluid will enter the pump at the left side (inlet) and be discharged at the **right** side (outlet).

Clockwise (CW) Rotation of Motor Shaft:

Fluid will enter the pump at the right side (inlet) and be discharged at the **left** side (outlet).

Section 4: Start-Up & Operation

4.1 Precautions Prior to Starting Pump

- 1) Verify that the pump and motor are suitable for the conditions of service.
- 2) Verify that all suction and discharge valves are open before starting the pump.
- 3) Prime the pump and jog the motor to check the direction of rotation. As viewed from the pump end, a clockwise rotation of the motor will result in fluid discharge from the left port; counter-clockwise rotation will result in fluid discharge from the right port (see Page 10).
- 4) The pump is capable of pulling a dry lift, but it is still recommended that the pump be primed prior to starting.
- 5) A **pressure relief valve** should be installed in the discharge line to protect the pump and piping from any kind of line blockage including the inadvertent closing of an isolation valve.
- 6) If the fluid contains suspended solids, a **filter** of at least 400 U.S. Mesh should be installed in the suction line. Concentration of solids should be limited to 1% by volume.

4.2 Operating Requirements

- 1) Do not operate the pump without fluid inside it.

**Caution!**

Do not run the pump dry for more than a few seconds or damage to internal parts can result.

- 2) The pump should be operated with at least 20 PSI (1.4 bar) differential pressure to ensure that internal components are properly lubricated by the pumped fluid.
- 3) Adequate suction pressure must be available for the pump to function properly (see NPSHR data on Page 4).
- 4) Do not operate the pump outside of its design specifications (see Page 4).

4.3 Troubleshooting

A normally operating magnetic-drive gear pump will deliver a steady, pulse-less flow with no leakage, be relatively quiet and have a predictable flow rate based on the pump speed, fluid viscosity and differential pressure across the pump. Refer to the performance curves of the specific pump model being operated (see Liquiflo Product Catalog or website: www.liquiflo.com).

During pump operation, inspect for: (1) Unusual noise, (2) Product leakage, (3) Expected suction and discharge pressures and (4) Expected flow rate based on pump speed, fluid viscosity and differential pressure. If any problems occur, stop the pump and take corrective action. For help with problem solving, refer to the Troubleshooting Guide given in **Appendix 4**.

Section 5: Maintenance & Repair

The pump has internal bearing-wear plates, wave springs and gear-shaft assemblies which require replacement over time due to wear. Standard repair kits are available to facilitate repair of the pump. The repair kits for the 2-Series pumps contain the drive and idler gear-shaft assemblies, bearing-wear plates, wave springs, housing alignment pins and O-rings (see **Appendix 2**). The O-rings (for the housing and containment can) should always be replaced when rebuilding the pump.

The main factors affecting the physical wear of the pump are operating speed, differential pressure, fluid viscosity, duty cycle, starting and stopping frequency, abrasives in the fluid and the wear properties of the materials. These factors can cause pump lifetimes to vary significantly from one application to another, making it difficult to predict when the pump will require maintenance. Therefore, the maintenance schedule for the pump is typically based on the maintenance history of the specific application. The main indicators that a pump may require maintenance are the following: (1) decreased flow rate or pressure, (2) fluid leakage, (3) unusual noise or vibrations and (4) increased power consumption.

5.1 Work Safety

Before performing maintenance, review the Safety Precautions given in **Section 2** (see Page 7).

**Caution!**

The Magnetic Couplings used in these pumps contain strong magnets. Observe the precautions given in Section 2.2.

5.2 Removal from System

**Caution!**

If the pump was used to move hazardous or toxic fluids, it must be flushed and decontaminated prior to removal from the system piping. Refer to the Material Safety Data Sheet (MSDS) for the liquid and follow all prescribed safety precautions and disposal procedures.

- 1 Flush the pump.
- 2 Stop the motor and lock out the electrical panel.

**Caution!**

Be certain the pump's motor switch is in the OFF position and the power to the motor is locked out.

- 3 Close the suction and discharge isolation valves.
- 4 Disconnect the pump from the system piping.

5.3 PUMP DISASSEMBLY

Follow the procedure below and refer to the drawings in **Appendix 3**.

Removal of Pump from Motor:

- 1
 - a. Remove the four mounting bolts (16) which secure the mounting bracket (14) to the motor.

NOTE: The pump is shown mounted to a NEMA 48C motor frame. The pump bracket is designed to mount directly to NEMA 48C and IEC 71 (B14 Face) motor frames.



- b. Separate the pump and mounting bracket assembly from the motor by pulling it straight out.



Caution!

Do not place hands or fingers between the C-faces of the Motor and Pump Bracket.

NOTE: Force must be applied to overcome the magnetic attraction between the outer and inner magnets.

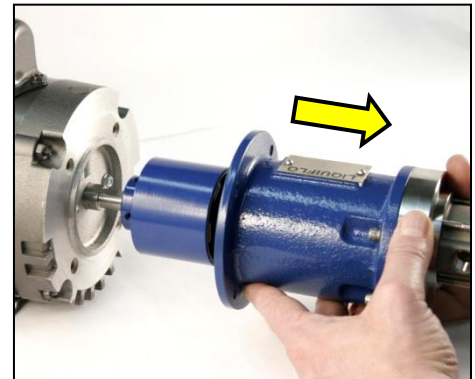

Caution!

The next step will separate the containment can from the pump, which will contain residual fluid that may be hazardous. Be careful not to contact or spill any residual fluid once the containment can is free.

Removal of Containment Can & Inner Magnet:

- 2
 - a. Remove the four screws (4) which secure the front housing (8) to the mounting bracket (14).

NOTE: Orient the pump as shown. This will capture the residual fluid in the containment can. Once the screws are removed, the containment can is no longer secured to the pump.



- 2
 - b. Separate the pump module from the bracket. Remove the inner magnet (10) and dispose of any residual liquid in the containment can (11). Discard the containment can O-ring (13).

 **Caution!** *The Containment Can and Inner Magnet are no longer secured to the pump. Be careful not to drop the Inner Magnet or spill any residual liquid existing inside the can.*

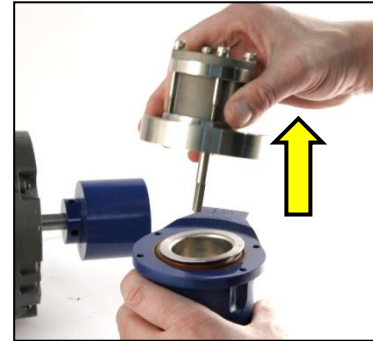

NOTE: The inner magnet is free to move axially on the drive shaft, by design. When the pump module is removed, as shown, the inner magnet should stay in the containment can.

Removal of Internal Parts from Pump Module:

- 3
 - a. Remove the four housing bolts (7) that hold the front housing (8), center housing (2) and end cap (12) together.



- b. Separate all parts and dispose of the bearing-wear plates (3), gear-shaft assemblies (1 & 15) and housing O-rings (5).

NOTE: The gears and shafts are permanently attached and are not meant to be separated. Liquiflo Repair Kits contain the gears and shafts preassembled, as shown at right. The gear-shaft assemblies can also be purchased separately (see **Appendix 2**).



Removal of Outer Magnet:

- 4

If necessary, remove the outer magnet as follows:

 - a. Loosen the two setscrews (6) on the hub of the outer magnet (9).
 - b. Remove the outer magnet from the motor shaft.

NOTE: Move the outer magnet to a safe location away from the inner magnet, tools and other metal objects.



END OF DISASSEMBLY PROCEDURE

5.4 PUMP ASSEMBLY

Follow the procedure below and refer to the drawings in **Appendix 3**.

- 1 Verify that you have all the parts required to assemble the pump.

NOTE: Refer to the cross-sectional drawing on Page 23.



- 2 Install two housing pins (20) and O-ring (5) into front housing (8), as shown.

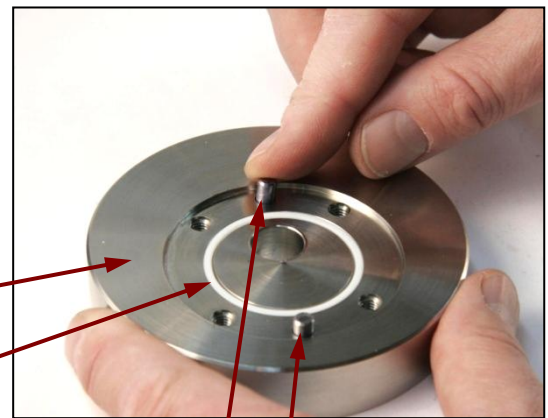

Front Housing

Housing O-ring

Housing Alignment Pins

Bearing-Wear Plate Installation

The 2-Series pumps use a combination bearing and wear plate design. All four bearing-wear plates are identical. When installing the bearing-wear plates, the **counter-bored sides** must face away from the gears (see photo).

NOTE: Failure to correctly orient the bearing-wear plates will cause a reduction in pump performance and operating life.

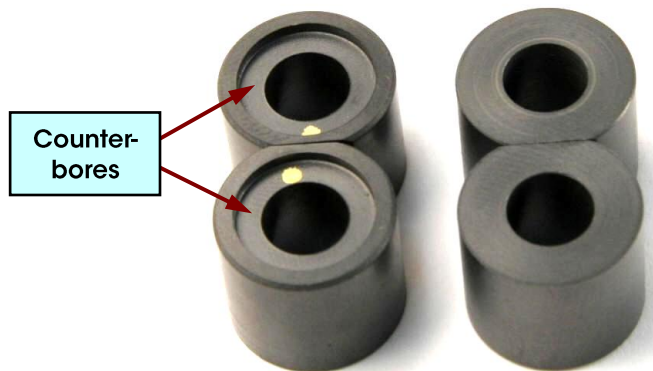

Counter-bores

- 3** Place the machined end of the center housing (2) over the alignment pins (20) and into the counter-bore on the front housing (8), as shown.

NOTE: Be certain the center housing seats properly over the alignment pins in the front housing. The housing pins serve to accurately align the front and center housings.

Machined End of Center Housing

Front Housing

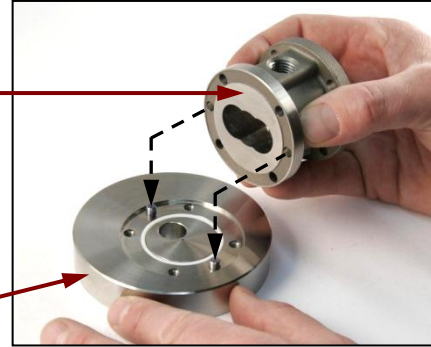

- 4** Insert two bearing-wear plates (3) into the center housing (2) with the counter-bores facing down.

NOTE: The flat sides of the bearing-wear plates must be facing each other.

Bearing-Wear Plates with Counter-bores facing down

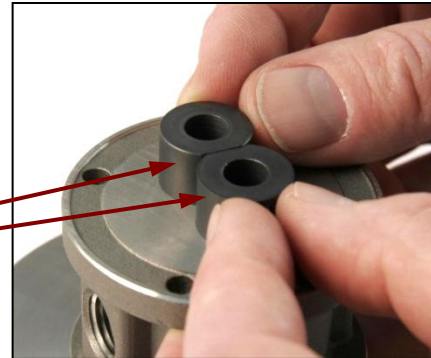

Installation of Gear-Shafts:

- 5** Insert the drive gear-shaft assembly (15) and the idler gear-shaft assembly (1) into the center housing (2).

NOTE: The square end of the drive shaft must protrude thru the bore in the front housing after installation. Refer to the cross-sectional drawing on Page 23.

Drive Gear-Shaft Assembly

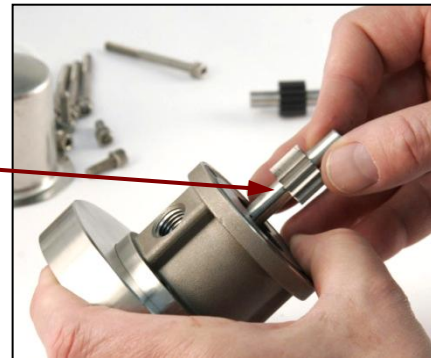

- 6** Insert two bearing-wear plates (3) into the center housing (2) with the counter-bores facing up.

NOTE: The flat sides of the bearing-wear plates must be facing each other.

Bearing-Wear Plates with Counter-bores facing up

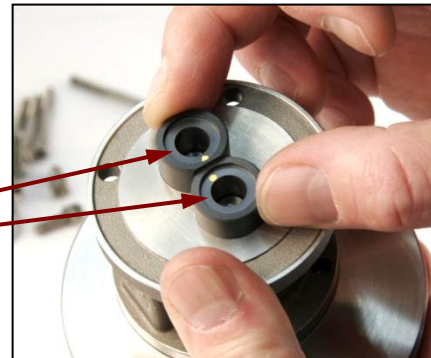

Installation of Wave Springs:

- 7** Place one wave spring (17) into the counter-bore of each bearing-wear plate (3), as shown.

NOTE: The wave springs enable the pump to self-prime and limit slip when pumping low-viscosity fluids.

Wave Springs

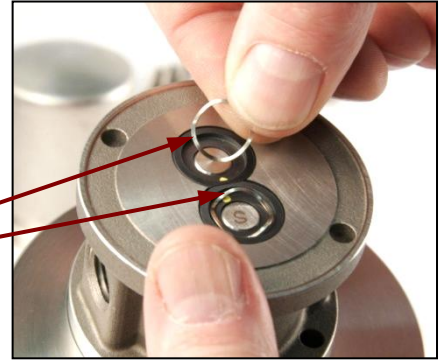

- 8** Install O-ring (5) into the circular groove of the end cap (12).



Caution!
Do not reuse O-rings.

Housing O-ring



- 9** Place end cap (12) into position on center housing (2); then install four bolts (7) with lockwashers (21).

End Cap



- 10** Carefully tighten the bolts in a crisscross pattern, as shown.

NOTE: The crisscross torque pattern will ensure even compression on the surfaces of the housing O-rings. With Teflon O-rings, the bolts may need to be retightened several times because of the cold flow characteristic of PTFE. Refer to **Appendix 1** for the torque specifications of the fasteners.



Installation of Inner Magnet:

- 11 Slide the inner magnet (10) on the drive shaft, oriented as shown.

NOTE: Turn the inner magnet by hand to ensure that the gears will rotate freely inside the housing with no more than a slight amount of drag. The inner magnet is free to move axially along the drive shaft, by design. Once the pump is fully assembled, the outer magnet will automatically pull the inner magnet into position.

Inner Magnet

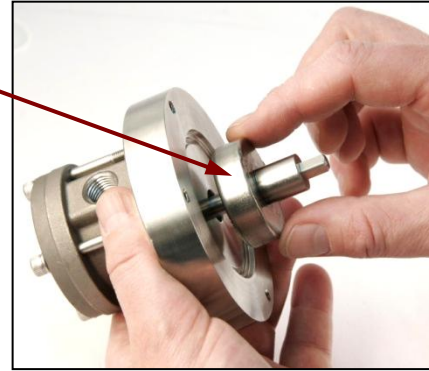

- 12 Install O-ring (13) into the circular groove on the front housing (8).



Caution!
Do not reuse O-rings.

Containment Can O-ring



Installation of Containment Can & Mounting Bracket:

- 13 a. Place the containment can (11) over the inner magnet (10) and onto the front housing (8).

NOTE: The containment can should seat naturally into the counter-bore on the front housing.

Containment Can

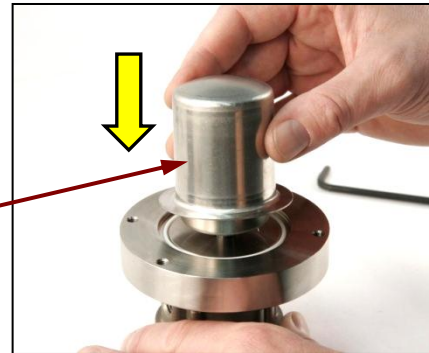

- b. Install mounting bracket (14) to the front housing (8), as shown, using four bolts (4) with lock-washers (22); then tighten the bolts.

NOTE: Tighten the bolts in a crisscross pattern to ensure even compression on the O-ring's surface. With Teflon O-rings, the bolts may need to be retightened several times because of the cold flow characteristic of PTFE. Refer to **Appendix 1** for the torque specifications of the fasteners.

Mounting Bracket



Installation of Outer Magnet

The outer magnets for the 2-Series pumps are available with three different bore sizes to allow installation on the shafts of standard motor frames (see table below). (Note: The motors must have feet to support the pump.)

Standard Motor Frame	Motor Shaft Diameter or Outer Magnet Bore Size
NEMA 48C	1/2 in.
IEC 71 (B14 Face)	14 mm
NEMA 56C	5/8 in.

Each outer magnet for the 2-Series Pumps has the same method of installation on the corresponding motor frame. As shown in the diagrams below, the outer magnet is positioned on the motor shaft by a snap ring installed in the hub of the outer magnet. The outer magnet is in position once the snap ring contacts the end of the motor shaft. Two cup-point setscrews are used to lock the outer magnet in position on the motor shaft.

NEMA 48C or IEC 71 Motor Frames:

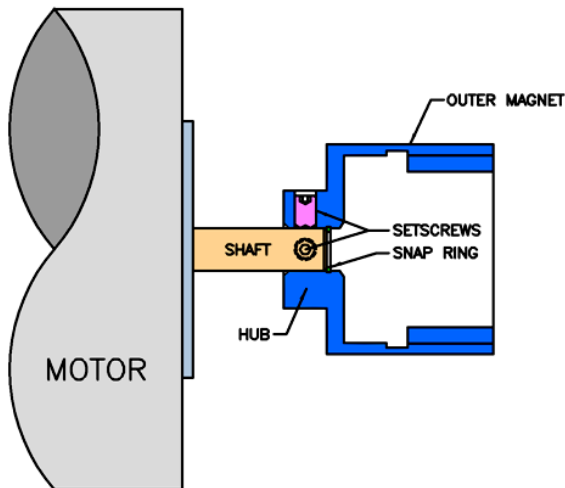

NEMA 56C Motor Frames:

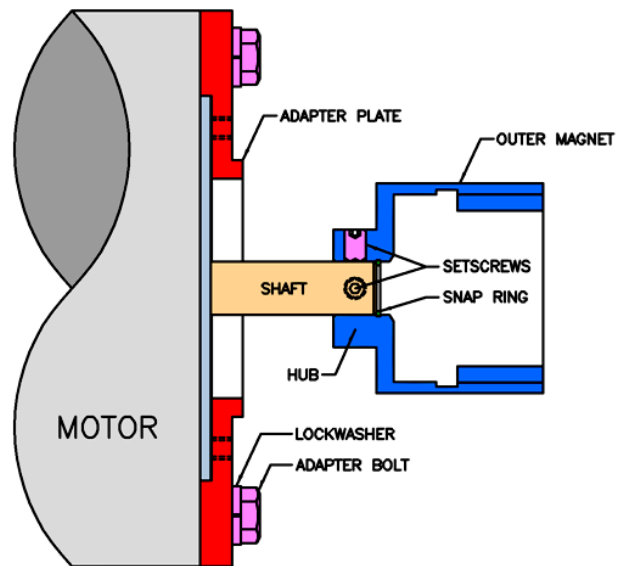

NOTE: The mounting bracket for the 2-Series Pumps is designed to mount directly to NEMA 48C and IEC 71 (B14 Face) motor frames. For NEMA 56C motor frames, an *adapter plate* is required to mount the pump to the motor. (See diagrams above.) Complete pumps ordered for use with NEMA 56C motor frames will be supplied with the *adapter plate*, *adapter mounting bolts* and *lockwashers* (see **Appendix 2** for Part Numbers).

Installation of Outer Magnet:

- 14
 - a. Apply a small amount of anti-seize compound to the motor shaft.
 - b. Slide the outer magnet (9) on the motor shaft and position the hub as shown on Page 19.
 - c. Tighten both setscrews (6) on the hub of the outer magnet.



NOTE: For NEMA 56C and IEC 71 motors, the cup-point setscrews can be tightened on the round surface of the shaft. For NEMA 48C motors, one setscrew can be tightened on the flat surface of the shaft and the other on the round surface.

Installation of Pump to Motor:

15



Caution!
Do not place hands or fingers between Bracket and Motor C-faces. The Outer and Inner Magnets will suddenly pull together with significant force.

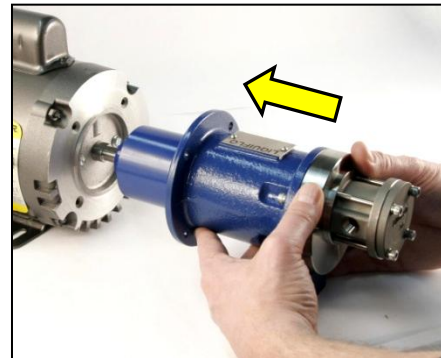

Carefully slide the pump bracket (14) over the outer magnet (9) and install onto motor using four mounting bolts (16) with lockwashers (23); then tighten the bolts.

NOTE: The C-faces of the bracket and motor should mate freely and mount flush.



NOTE: See **Appendix 1** for the torque specifications of the fasteners.



2-Series Mini Pump shown Close-Coupled to NEMA 48C Motor Frame

NOTE: To mount the pump to a NEMA 56C motor frame, an *adapter plate* is required which attaches to the motor (see Page 19). The pump bracket will mount to the motor adapter plate and the foot of the bracket will not touch the ground (see Page 25). A shim or extra support underneath the foot is not required.

END OF ASSEMBLY PROCEDURE

Appendix 1: Fastener Torque Specifications**Maximum Torque Values for 18-8 Stainless Steel Bolts**

Function	Bolt Size	Bolt Type	Quantity (per Pump)	Max Torque Specifications	
				(in-lbs)	(N-m)
Housing Assembly	#10-32 UNF x 2 1/8	SHCS	4	31.7	3.58
Pump-Bracket Assembly	#10-32 UNF x 5/8	SHCS	4	31.7	3.58
BOLTS for MOTOR-BRACKET ASSEMBLY:					
Motor ¹ -Bracket Assembly	1/4-20 UNC x 1/2	SHCS	4	75.2	8.50
Motor ² -Bracket Assembly	M6 x 20 mm	SHCS	4	67.2	7.60
Motor ³ -Adapter Assembly	3/8-16 UNC x 1	HHCS	4	236	26.7
Adapter ³ -Bracket Assembly	1/4-20 UNC x 1/2	SHCS	4	75.2	8.50

- 1 - NEMA 48C motor frame
2 - IEC 71 (B14 Face) motor frame
3 - NEMA 56C motor frame

SHCS = Socket Head Cap Screw
HHCS = Hex Head Cap Screw

Appendix 2: Pump Bill of Materials (BOM)

2-Series Mini Pump BOM

Ref. #	Description		Material	Part Number		Qty.
				Model 2R	Model 2F	
1	Idle Gear-Shaft Assembly		316SS - 316SS	206063	206047	1
			316SS - 316SS/CO	206066	206050	
			316SS - 316SS/TC	206064	206048	
			PEEK - 316SS	206071	206055	
			PEEK - 316SS/CO	206074	206058	
		PEEK - 316SS/TC	206072	206056		
2	Center Housing	NPT Ports	316 SS	200011	200011	1
		BSPT Ports	316 SS	200009	200009	
3	Bearing - Wear Plate		Carbon-60	204022	204020	4
			PEEK	204023	204021	
4	Bolt, Front Housing (#10-32 x 1/2 SHCS)		18-8 SS	620823	620823	4
5	O-ring, Housing (2-028)		Teflon	207015	207015	2
			Viton	207016	207016	
			Kalrez	207020	207020	
6	Setscrew (1/4-28 x 3/8 SHSS-CP)		Carbon Steel	421104	421104	2
7	Bolt, Housing (#10-32 x 2 1/8 SHCS)		18-8 SS	620842	620842	4
8	Front Housing		316SS	200012	200012	1
9	Outer Magnet	1/2" Bore (NEMA 48C)	Carb. Steel/SmCo/Epoxy	SOMCX-4	SOMCX-4	1
		14 mm Bore (IEC 71)	Carb. Steel/SmCo/Epoxy	SOMCX-71	SOMCX-71	
		5/8" Bore (NEMA 56C)	Carb. Steel/SmCo/Epoxy	SOMCX-5	SOMCX-5	
10	Inner Magnet		316 SS/SmCo	SIMCX-02	SIMCX-02	1
11	Containment Can		316 SS	205011	205011	1
12	Rear Housing (End Cap)		316 SS	212026	212026	1
13	O-ring, Containment Can (2-033)		Teflon	341102	341102	1
			Viton	341108	341108	
			Kalrez	341109	341109	
14	Mounting Bracket	NEMA 48C & 56C	Cast Iron/Epoxy	442200	442200	1
		IEC 71 (B14 Face)	Cast Iron/Epoxy	442201	442201	
15	Drive Gear-Shaft Assembly		Alloy-C - 316SS	206091	206083	1
			Alloy-C - 316SS/CO	206094	206086	
			Alloy-C - 316SS/TC	206092	206084	
			316SS - 316SS	206087	206079	
			316SS - 316SS/CO	206090	206082	
		316SS - 316SS/TC	206088	206080		
16	Bolt, Mounting (1/4-20 x 1/2 SHCS) *		18-8 SS	S314008	S314008	4
17	Wave Spring		316 SS	207028	207028	2
18	Adapter Plate - NEMA 56C Motor **		Carbon Steel/Epoxy	442203	442203	1
19	Bolt, Adapter (3/8-16 x 1 HHCS) **		18-8 SS	620825	620825	4
20	Pin, Housing Alignment		316 SS	207038	207038	2
21	Lockwasher, Housing (#10)		18-8 SS	5018	5018	4
22	Lockwasher, Front Housing (#10)		18-8 SS	5018	5018	4
23	Lockwasher, Mounting (1/4)		18-8 SS	863701	863701	4
24	Lockwasher, Adapter (3/8) **		18-8 SS	S1004	S1004	4
25	Bumper, Mounting Bracket		Viton	442101	442101	1

* For NEMA 48C motor or 56C adapter.

** Part not required for NEMA 48C or IEC 71 motor frames.

NOTE: Items 1, 3, 5, 13, 15, 17 and 20 are included in a standard 2-Series Repair Kit. To order a Repair Kit for an existing 2-Series pump, simply place a "K" in front of the Pump Model Number to designate the **Kit Order Number**. Example: **K2FS6PE200X**. Using this ordering number will ensure that the kit component materials will match those used in the pump. (See Page 5 for Model Coding information.)

Appendix 3: Reference Drawings

Cross-Sectional Drawing – 2-Series Mini Pump

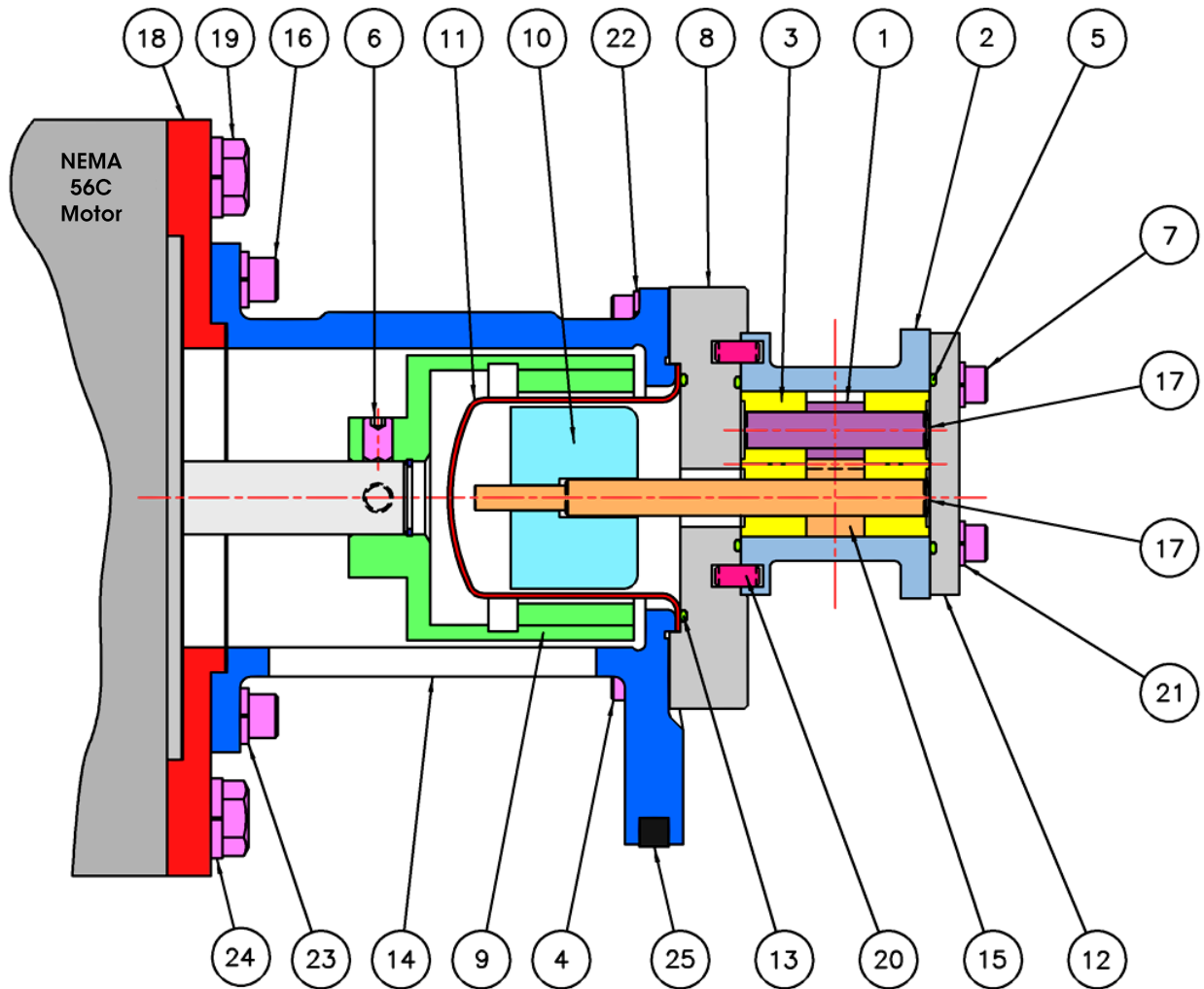

Ref. #	Description	Qty.	Ref. #	Description	Qty.
1	Idler Gear-Shaft Assembly	1	14	Mounting Bracket	1
2	Center Housing	1	15	Drive Gear-Shaft Assembly	1
3	Bearing-Wear Plate	4	16	Bolt, Mounting (1/4-20 x 1/2 SHCS)	4
4	Bolt, Front Hsg. (#10-32 x 1/2 SHCS)	4	17	Wave Spring	2
5	O-ring, Housing	2	18	Adapter - NEMA 56C Motor *	1
6	Setscrew (1/4-28 x 3/8 SHSS-CP)	2	19	Bolt, Adapter (3/8-16 x 1 HHCS) *	4
7	Bolt, Housing (#10-32 x 2 1/8 SHCS)	4	20	Pin, Housing Alignment	2
8	Front Housing	1	21	Lockwasher, Housing (#10)	4
9	Outer Magnet (Assembly)	1	22	Lockwasher, Front Housing (#10)	4
10	Inner Magnet (Assembly)	1	23	Lockwasher, Mounting (1/4)	4
11	Containment Can	1	24	Lockwasher, Adapter (3/8) *	4
12	Rear Housing (End Cap)	1	25	Bumper, Mounting Bracket	1
13	O-ring, Containment Can	1	26	N/A	-

* Item not required for NEMA 48C or IEC 71 motor frames. IEC 71 motor must have B14 Face.

NOTE: For Liquiflo Part Numbers, see Page 22.

Appendix 3: Reference Drawings (Continued)

Exploded View Drawing – 2-Series Mini Pump

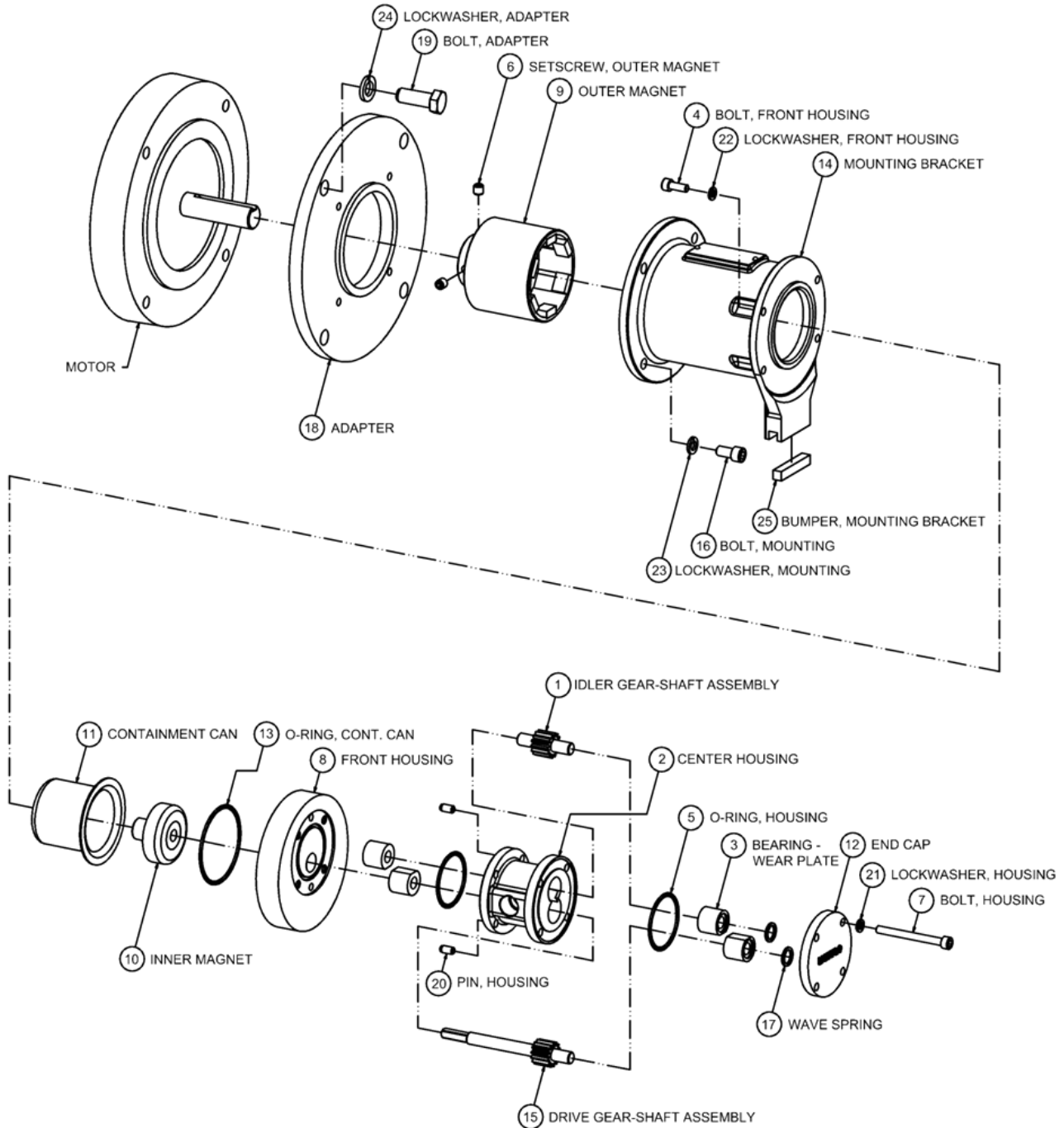

NOTE: NEMA 56C motor frame is shown. Items 18, 19 and 24 are not required for NEMA 48C or IEC 71 motor frames. IEC 71 motor must have B14 Face to be compatible with Mounting Bracket.

Appendix 3: Reference Drawings (Continued)

Dimensional Drawings – 2-Series Mini Pump

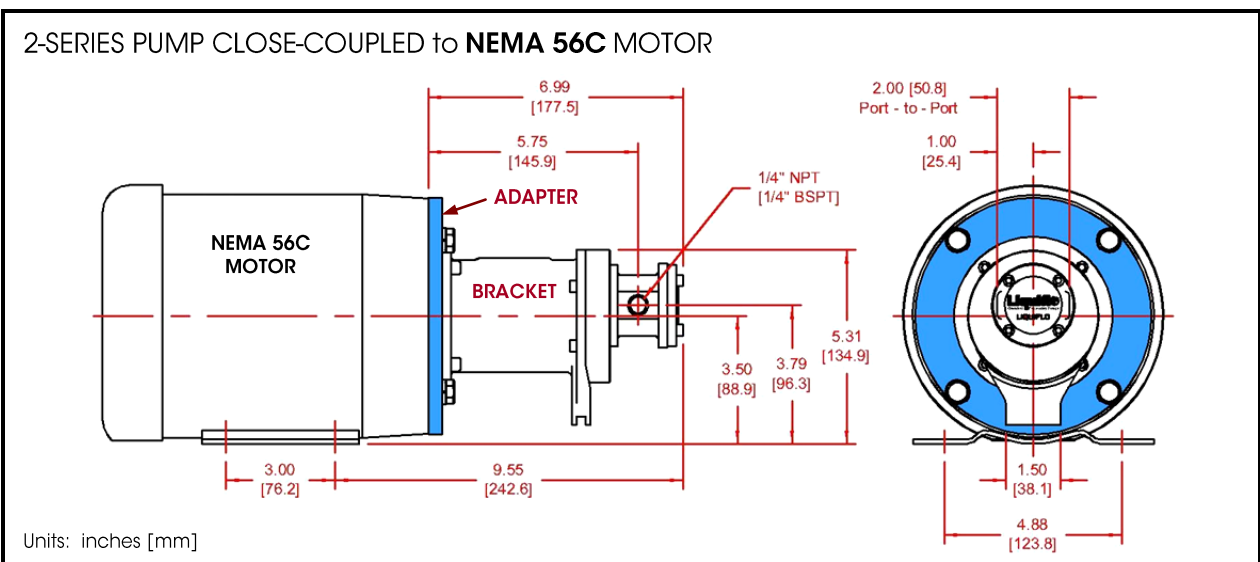
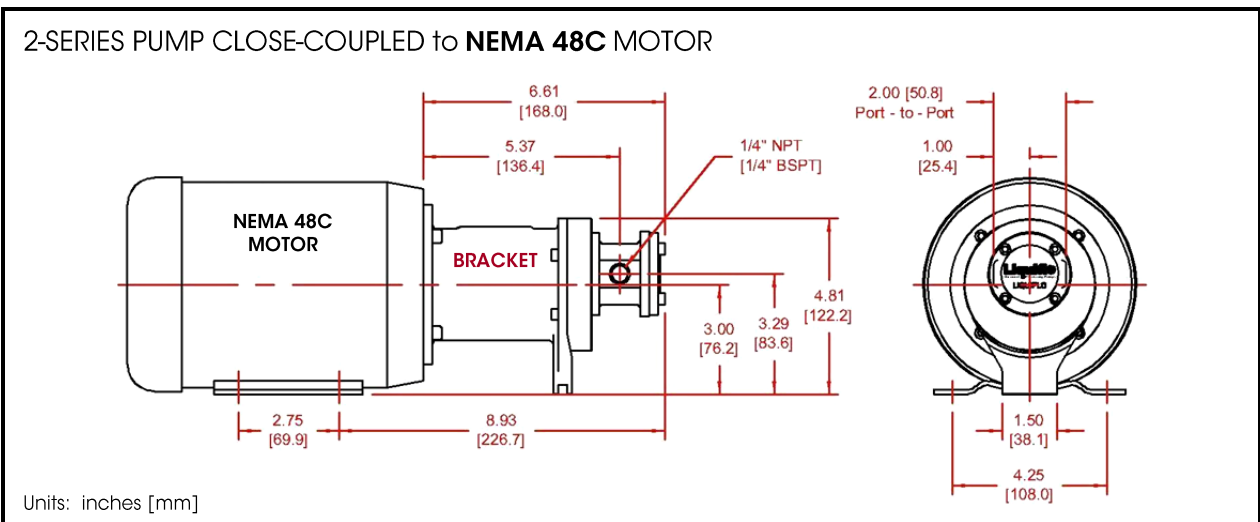
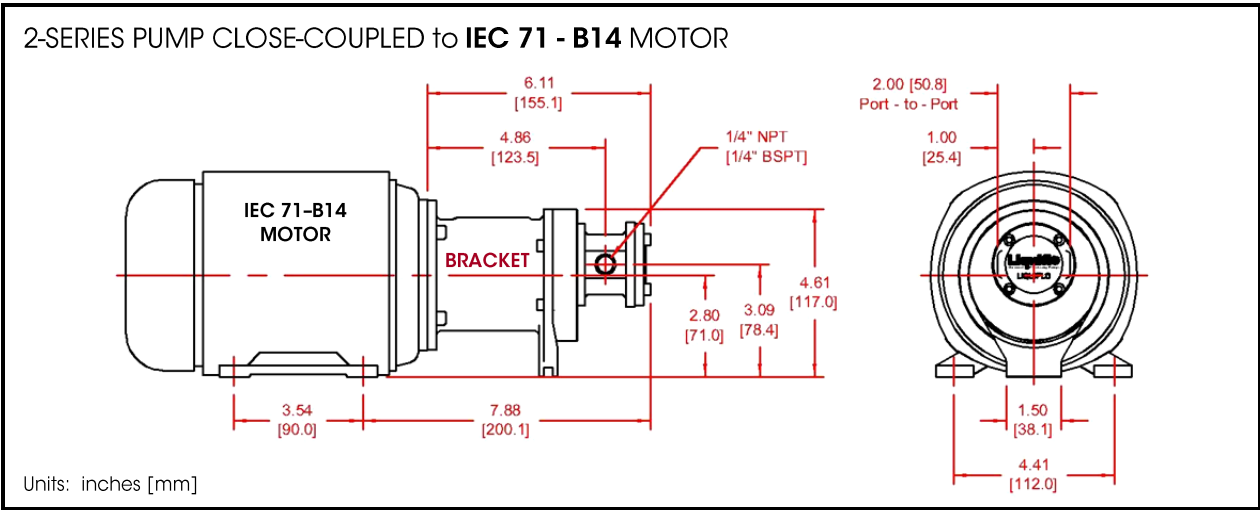

Appendix 4: Troubleshooting Guide

Troubleshooting Guide - Part 1

Problem	Possible Cause	Corrective Action
No discharge	Pump not primed	Verify suction pipe is submerged. Increase suction pressure. Open suction valve.
	Wrong direction of rotation	Reverse motor leads or reverse suction and discharge piping.
	Valves closed	Open all suction and discharge valves.
	Bypass valve open	Close bypass valve.
	Air leak in suction line	Tighten connections. Apply sealant to all threads. Verify suction pipe is submerged.
	Clogged strainer	Clean strainer.
	Magnetic coupling has decoupled	Stop driver and then check temperature and viscosity of fluid. Restart driver and then check flow.
	Pump parts worn or damaged	Rebuild pump.
Insufficient discharge	Suction pressure too low	Increase suction pressure. Verify suction piping is not too long. Fully open any suction valves.
	Bypass valve open	Close bypass valve.
	Partly clogged strainer	Clean strainer.
	Speed too low	Increase driver speed, if possible. Use larger size pump, if required.
	Pump parts worn or damaged	Rebuild pump.
Loss of suction after satisfactory operation	Pump not properly primed	Reprime pump.
	Air leak in suction line	Tighten connections. Apply sealant to all threads. Verify suction pipe is submerged.
	Air or vapor pockets in suction line	Rearrange piping as necessary.
	Increase in fluid viscosity	Heat fluid to reduce viscosity. Reduce pump speed.
Excessive power consumption	Fluid viscosity higher than specified	Heat fluid to reduce viscosity. Reduce pump speed. Increase driver horsepower.
	Differential pressure greater than specified	Increase pipe diameter. Decrease pipe run.
	Plastic gear clearance insufficient for fluid temperature	Purchase plastic gear trimmed for the correct temperature.
	Rotating parts binding or severely worn	Disassemble pump and replace worn parts.

Appendix 4: Troubleshooting Guide (Continued)**Troubleshooting Guide - Part 2**

Problem	Possible Cause	Corrective Action
Rapid pump wear	Abrasives in fluid	Install suction strainer. Limit solids concentration. Reduce pump speed or use larger pump running at lower speed.
	Corrosion wear	Use materials of construction that are acceptable for fluid being pumped.
	Extended dry running	Install power sensor to stop pump.
	Discharge pressure too high	Increase pipe diameter. Decrease pipe run.
	Housing stress from piping	Align piping with pump ports. Support piping independently of pump.
Excessive noise and vibration	Suction and/or discharge piping not anchored or properly supported	Anchor per Hydraulic Institute Standards.
	Motor and/or base not properly mounted or secured	Tighten motor mounting bolts to proper torque specification. Secure base to the ground.
	Worn pump bearings	Replace bearings.
	Worn motor bearings	Replace bearings or motor.
	Pump cavitation	Increase NPSH available.
Excessive product leakage	Static seal failure caused by chemical or thermal breakdown	Use O-rings or gaskets made of material compatible with fluid and temperature of the application.
	Static seal failure caused by improper installation	Install O-rings or gaskets without twisting or bending. Use star-pattern torque sequence on housing bolts during assembly. Allow Teflon O-rings to cold flow and seat during tightening. Torque bolts to specification.
	Pump port connections not properly sealed	Use Teflon tape or other suitable sealant.
	Crevice corrosion of pump housing material	Only pump chemicals that are compatible with the pump housing material. Decrease temperature to reduce corrosion rate to acceptable value. Flush idle pumps that are used to pump corrosive chemicals. Eliminate contaminants in the fluid that can accelerate corrosion wear.