

H-SERIES & 3-SERIES

SEALED, LONG-COUPLED GEAR PUMPS

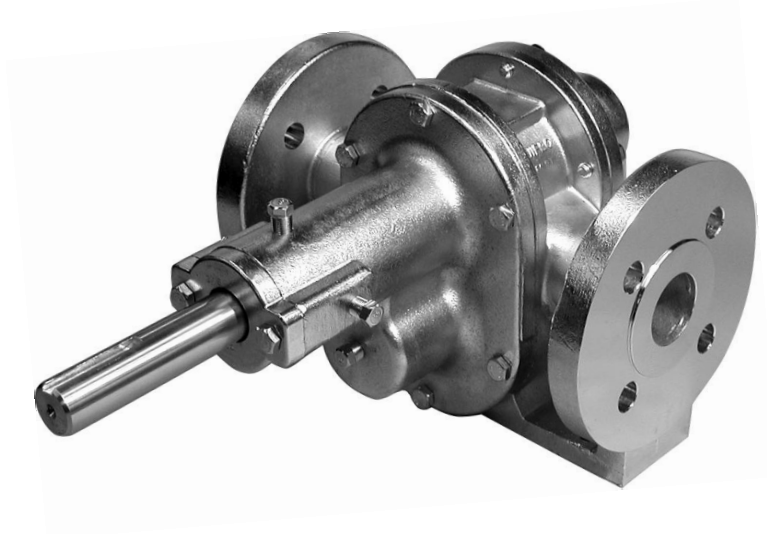

H-SERIES: Models H12R, H12F & H14F

3-SERIES: Models 312R, 312F & 314F

Table of Contents

	Introduction	2
Section 1:	General Information	3-8
Section 2:	Safety Precautions	9
Section 3:	Pump & Motor Installation	10-12
Section 4:	Start Up & Operation	13
Section 5:	Maintenance & Repair	14-31
	Appendix	32-53

Introduction

This manual provides instructions for the installation, operation and maintenance of the H-Series & 3-Series Sealed Gear Pumps, Models H12R, H12F, H14F, 312R, 312F & 314F, with Long-Coupled (LC) configuration. It is critical for any user to read and understand the information in this manual along with any documents this manual refers to prior to installation and start-up.

Liquiflo shall not be liable for damage or delays caused by a failure to follow the instructions for installation, operation and maintenance as outlined in this manual.

Thank you for purchasing a Liquiflo product.

LIQUIFLO STANDARD TERMS AND CONDITIONS APPLY UNLESS SPECIFIED IN WRITING BY LIQUIFLO.

Detailed Table of Contents

<p>1. General Information</p> <p> 1.1 General Instructions 3</p> <p> 1.2 Pump Specifications 4-5</p> <p> 1.3 Model Coding 6</p> <p> 1.4 Pump Installation 7</p> <p> 1.5 Start-Up 7</p> <p> 1.6 Operation & Troubleshooting 7</p> <p> 1.7 Maintenance & Repair 7-8</p> <p> 1.8 Repair Kits & Replacement Parts 8</p> <p> 1.9 Returned Merchandise Authorization (RMA) . . 8</p> <p>2. Safety Precautions</p> <p> 2.1 General Precautions 9</p> <p>3. Pump & Motor Installation</p> <p> 3.1 Installation of Pump, Motor & Base 10</p> <p> 3.2 General Piping Requirements 10-11</p> <p> 3.3 Gear Pump Requirements 11</p> <p> 3.4 General Motor Requirements 11-12</p> <p> 3.4.1 Motor Selection 11-12</p> <p> 3.4.2 Motor Hook-Up 12</p> <p> 3.4.3 Motor Direction 12</p> <p>4. Start-Up & Operation</p> <p> 4.1 Precautions Prior to Starting Pump 13</p> <p> 4.2 Operating Requirements 13</p> <p> 4.3 Troubleshooting 13</p>	<p>5. Maintenance & Repair</p> <p> 5.1 Work Safety 14</p> <p> 5.2 Removal from System 14</p> <p> 5.3 Pump Disassembly 15-18</p> <p> Removal of Seals 15-17</p> <p> Removal of Internal Parts 18</p> <p> Gear-Shaft Disassembly 18</p> <p> 5.4 Pump Assembly 19-31</p> <p> Installation of Bearings 19</p> <p> Internal Bearing Flush Option 19</p> <p> Installation of Wear Plates 21</p> <p> Installation of Gear-Shafts 21</p> <p> Installation of Seals 23-31</p> <p> A. Packing Seal 23-24</p> <p> B. Single Internal Mech. Seal 25-27</p> <p> C. External Mechanical Seal 28</p> <p> D. Double Mechanical Seal 29-31</p> <p>Appendix:</p> <p> A-1: Fastener Torque Specifications 32</p> <p> A-2: Maintenance Tool List 33</p> <p> A-3: Repair Kits 34-35</p> <p> A-4: Wear Allowances 36-38</p> <p> A-5: Gear-Shaft Assembly 39-43</p> <p> A-6: Reference Drawings 44-49</p> <p> A-7: Operation of Dynamic Seals 50-51</p> <p> A-8: Troubleshooting Guide 52-53</p> <p>Notes 54-55</p>
--	--

Section 1: General Information

1.1 General Instructions

This manual covers the H-Series Sealed, Long-Coupled Gear Pumps, Models H12R, H12F and H14F; and the 3-Series Sealed, Long-Coupled Gear Pumps, Models 312R, 312F and 314F.

The materials of construction of the pump are selected based upon the chemical compatibility of the fluid being pumped. The user must verify that the materials are suitable for the surrounding atmosphere.

If the fluid is non-conductive, methods are available to mechanically ground the isolated shaft. This is only necessary if the surrounding atmosphere is extremely explosive or stray static charges are present.

Upon receipt of your Liquiflo pump:

- A) Verify that the equipment has not been damaged in transit.
- B) Verify that the pump Serial Number is stamped on the pump's rear housing.
- C) Verify that the Liquiflo Stainless Steel Nameplate is secured to the pump's housing:



- D) For ATEX certification, verify that the following Stainless Steel Tag is attached to the pump:

Explanation of ATEX Tag	
Group II	Explosive atmospheres
Category 2	Equipment provides a high level of protection. Explosive atmospheres are likely to occur.
Category 3	Equipment provides a normal level of protection. Explosive atmospheres are unlikely to occur.
D	Dust
G	Gas

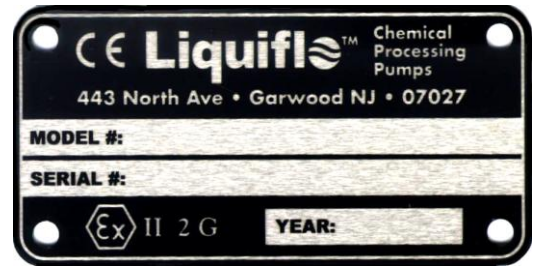

- E) Record the following information for future reference:

Model Number:
Serial Number:
Date Received:
Pump Location:
Pump Service:

NOTE: By adding a **K** prior to the pump's Model Code, a **Repair Kit** can be obtained which consists of the following parts: Drive and idler gears, drive and idler shafts, wear plates, bearings, retaining rings, keys, housing alignment pins, bearing lock pins, O-rings and seal components. (See **Appendix 3** for more information.)

1.2 Pump Specifications

Table 1A: Performance Specifications (English System Units)

Pump Series	Pump Model	Max Flow	Max Speed	Max ΔP	Max Viscosity ⁽²⁾	NPSHR ⁽³⁾	Dry Lift ⁽³⁾	TD ⁽⁴⁾
	Units:	GPM	RPM	PSI	cP	ft	ft	GPR
H-Series	H12R	21.9	1150	225 ⁽¹⁾	100,000	5	15	.01907
	H12F	29.2	1150	225 ⁽¹⁾	100,000	5	17	.02543
	H14F	58.4	1150	225 ⁽¹⁾	100,000	3	20	.05086
3-Series	312R	21.9	1150	100	100,000	5	15	.01907
	312F	29.2	1150	100	100,000	5	17	.02543
	314F	58.4	1150	100	100,000	3	20	.05086

Table 1B: Performance Specifications (SI System Units)

Pump Series	Pump Model	Max Flow	Max Speed	Max ΔP	Max Viscosity ⁽²⁾	NPSHR ⁽³⁾	Dry Lift ⁽³⁾	TD ⁽⁴⁾
	Units:	LPM	RPM	bar	mPas	m	m	LPR
H-Series	H12R	83.0	1150	15.5 ⁽¹⁾	100,000	1.5	4.5	.07219
	H12F	110	1150	15.5 ⁽¹⁾	100,000	1.5	5.2	.09626
	H14F	220	1150	15.5 ⁽¹⁾	100,000	0.9	6.1	.19252
3-Series	312R	83.0	1150	6.9	100,000	1.5	4.5	.07219
	312F	110	1150	6.9	100,000	1.5	5.2	.09626
	314F	220	1150	6.9	100,000	0.9	6.1	.19252

NOTES:

- 1 Max ΔP (Differential Pressure) is derated to 125 PSI (8.6 bar) for viscosities < 10 cP (mPas).
- 2 Fluid viscosities > 150 cP (mPas) should use pumps with trimmed gears to reduce power consumption and increase pump efficiency. High-viscosity fluids may require larger pumps with trimmed gears operating at lower speeds. Consult factory.
- 3 NPSHR and Dry Lift are Specified @ Max Speed and 1 cP (mPas).
- 4 TD (Theoretical Displacement) is based on new pump operating @ Max Speed and $\Delta P = 0$.

Table 2: Absolute Temperature & Pressure Ratings

Pump Series	Pump Models	Minimum Operating Temperature		Maximum Operating Temperature ⁽¹⁾		Maximum Operating Pressure ⁽³⁾		
		Units:	°F	°C	°F	°C	PSIG	bar (g)
H-Series	H12R, H12F & H14F		-40	-40	500	260	270	18.6
3-Series	312R, 312F & 314F		-40	-40	500	260	270	18.6

NOTES:

- 1 The actual maximum surface temperature depends not on the pump but primarily on the temperature of the fluid being pumped. Temperature class can be controlled with the use of thermal sensors. Pump surfaces will be approximately 20 °F (7 °C) above the temperature of the fluid being pumped.
- 2 Pump is designed to operate within the ambient temperature range of -4 °F (-20 °C) and 104 °F (40 °C).
- 3 For pumps with ANSI 150# RF Flanges, the Maximum Operating Pressure Rating of the flange is 285 PSIG within the temperature range of -20 to 100 °F. Above 100 °F, derate by 0.3 PSIG/°F.

Table 3: Maximum Torque Specifications (in-lbs)

Gear Combination	H-Series	H12R	H12F	H14F ¹
	3-Series	312R	312F	314F
Idler Gear Teflon		101	134	268
Idler Gear Ryton		285	380	760
Idler Gear PEEK		285	380	760
Double Metal Gears		1558	1558	1558

¹ H14F offered with PEEK or 316 SS gear only.

Table 4: Weight Data

	H-Series	H12R	H12F	H14F	Units
	3-Series	312R	312F	314F	
Pump Weight *		52	52	67	lbs
		24	24	30	kg

* Approximate weight of pump with flanged ports.

Table 5: Material Data

Component		Materials
Pump Housing		316 Stainless Steel or Alloy-C (Note 3)
Mounting Hardware		18-8 Stainless Steel
Bearings		Carbon-60, Silicon Carbide, PEEK or Teflon (Notes 1 & 4)
Wear Plates		Carbon-60, Silicon Carbide, PEEK or Teflon (Note 1)
Gears		316 Stainless Steel, Alloy-C, PEEK, Ryton or Teflon (Notes 1 & 5)
Shafts	Base Metal	316 Stainless Steel or Alloy-C (Note 2)
	Coating	Uncoated, Ceramic Chrome Oxide or Tungsten Carbide (Note 6)
Housing Pins		316 Stainless Steel or Alloy-C (Note 2)
Bearing Pins		316 Stainless Steel or Alloy-C (Note 2)
Retaining Rings		316 Stainless Steel or Alloy-C (Note 2)
Keys		316 Stainless Steel or Alloy-C (Note 2)
O-rings		Teflon, Viton, EPDM, Buna-N, Kalrez or 316 SS/PFA Encapsulated
Dynamic Seal	Packing	Braided Teflon or Graphoil
	Mechanical Seals	Seal Face: Carbon or Teflon Seal Wedge: Teflon or Graphoil Seal Seat: Ceramic or Silicon Carbide Metallic Body: Single Internal: 316 Stainless Steel or Alloy-C (Note 2) External and Double: 316 Stainless Steel

NOTES:

- 1** Teflon is 25% glass-filled PTFE.
- 2** Material will match pump housing material.
- 3** Model H14F Housing offered in 316 SS only.
- 4** Model H14F Bearings offered in Carbon-60 and Silicon Carbide only.
- 5** Model H14F Gears offered in 316 SS and PEEK only.
- 6** Model H14F Shafts offered in Uncoated and TC-Coated only.

1.3 Model Coding

A 14-position **Model Code** is used to completely describe a specific sealed pump. This code is required when ordering either a new pump or a repair kit or replacement parts for an existing pump. The tables below describe the Model Code and give specific examples:

Table 6A: Sealed Pump Model Code Description & Example 1

Position #	Description	Pump Model Code Example 1: H12RS6333S100061	
		Code	Selection
1	Pump Model (Size)	H12	Model H12R (H12 = Pump Size; R = Reduced Capacity)
2	Pump Model (Capacity)	R	
3	Basic Material & Port Type	S	316 SS Housing and Shafts & NPT Ports
4	Drive Gear	6	316 SS Drive Gear
5	Idler Gear	3	Teflon Idler Gear
6	Wear Plates	3	Teflon Wear Plates
7	Bearings	3	Teflon Bearings
8	Sealing Method	S	Teflon/SiC Single Internal Mechanical Seal
9	Bearing Flush	1	Bearing Flush Plugs
10	Shaft Coating	0	Uncoated (Bare 316 SS Shafts)
11	O-rings	0	Teflon O-rings
12	Retaining Rings	0	316 SS Retaining Rings
13	Bearing Pins	6	316 SS Bearing Pins
14	Coupling Method	1	Long-Coupled
Suffix	Trim Option		No Trim Option

Table 6B: Sealed Pump Model Code Description & Example 2

Position #	Description	Pump Model Code Example 2: H14FL6PEEU220061-8(250)	
		Code	Selection
1	Pump Model (Size)	H14	Model H14F (H14 = Pump Size; F = Full Capacity)
2	Pump Model (Capacity)	F	
3	Basic Material & Port Type	L	316 SS Housing and Shafts & Flanged Ports
4	Drive Gear	6	316 SS Drive Gear
5	Idler Gear	P	PEEK Idler Gear
6	Wear Plates	E	Carbon-60 Wear Plates
7	Bearings	E	Carbon-60 Bearings
8	Sealing Method	U	Carbon/SiC Single Internal Mechanical Seal
9	Bearing Flush	2	Bearing Flush Plugs & Internal Bearing Flush
10	Shaft Coating	2	Tungsten Carbide (316 SS Base Metal)
11	O-rings	0	Teflon O-rings
12	Retaining Rings	0	316 SS Retaining Rings
13	Bearing Pins	6	316 SS Bearing Pins
14	Coupling Method	1	Long-Coupled
Suffix	Trim Option	-8(250)	Temperature Trim at 250°F

NOTE: See the Liquiflo Product Catalog or the Liquiflo Website (www.liquiflo.com) for complete Model Coding information.

1.4 Pump Installation

During installation of the pump and supporting equipment, follow the guidelines given in **Section 3**. Pay special attention to all cautionary notes in this section.

1.5 Start-Up

Before operating the pump, inspect the system as outlined in **Section 4**. Do not start the pump until the inspection is satisfactory and all safety precautions have been taken.

1.6 Operation & Troubleshooting

The successful and safe operation of a pump is not only dependent on the pump but also on each of the system components. It is therefore important to monitor the entire pumping system during operation and to perform the necessary maintenance to keep the system running smoothly.

A normally operating sealed gear pump will deliver a steady and pulse-less flow, be relatively quiet and have a predictable flow rate based on the pump speed, fluid viscosity and differential pressure across the pump. Refer to the performance curves of the specific pump model being operated (see Liquiflo Product Catalog or website: www.liquiflo.com). Sealed pumps operating normally will have virtually no leakage, except those with packing, which may require some leakage to properly lubricate the seal (see **Appendix 7**). Sealed pumps must not be run dry for more than a few seconds or damage to the seal will result.

If a significant problem is observed during operation, the pump should be stopped so that corrective action can be taken. The observed problem could have several possible causes, and multiple remedies for each cause. For help with problem solving, refer to the Troubleshooting Guide given in **Appendix 8**.

1.7 Maintenance & Repair

The pump has a dynamic seal and internal bearings, wear plates, gears and shafts which require replacement over time due to physical wear. The center housing of the pump may also incur physical wear and require replacement (see **Appendix 4**). O-rings and retaining rings should always be replaced when rebuilding the pump.

The main factors affecting the physical wear of the pump are operating speed, differential pressure, fluid viscosity, duty cycle, starting and stopping frequency, abrasives in the fluid and the wear properties of the materials. These factors can cause pump lifetimes to vary significantly from one application to another, making it difficult to predict when the pump will require maintenance. Therefore, the maintenance schedule for the pump is typically based on the maintenance history of the specific application. The main indicators that a pump may require maintenance are the following: (1) decreased flow rate or pressure, (2) fluid leakage, (3) unusual noise or vibrations and (4) increased power consumption.

Standard repair kits are available to facilitate repair of the pump (see **Appendix 3**). A repair kit for a sealed pump includes the following parts: seal components (packing rings or mechanical seal), bearings, wear plates, gear-shaft assemblies, O-rings, bearing lock pins and housing alignment pins. The single mechanical seal includes the outboard seal seat and the double mechanical seal includes both the inboard and outboard seal seats.

Before performing maintenance on the pump, review the safety precautions given in **Section 2**. Removal of the pump from the piping system is covered in **Section 5.2**. A maintenance tool list is provided in **Appendix 2**. To disassemble the sealed pump, follow the procedure in **Section 5.3**. To

replace the seal or other parts of the pump, follow the assembly procedure in **Section 5.4**. When performing maintenance, pay special attention to all cautionary notes given in these sections.

1.8 Repair Kits & Replacement Parts

Repair kits and replacement parts for the pumps can be purchased from your local Liquiflo distributor. Refer to **Appendices 3** thru **6** for repair kit and individual parts information.

1.9 Returned Merchandise Authorization (RMA)

If it is necessary to return the pump to the factory for service,

- 1) Contact your local Liquiflo distributor to discuss the return, obtain a Returned Merchandise Authorization Number (**RMA #**) and provide the distributor with the required information (see RMA Record below).
- 2) Clean and neutralize pump.
- 3) Package the pump carefully and include the **RMA #** in a visible location on the outside surface of the box.
- 4) Ship pump to factory, freight prepaid.

Returned Merchandise Authorization (RMA) Record		
1	RMA #	(Supplied by Distributor)
2	Distributor Name	
3	Order Date	
4	Customer PO #	
5	Return Date	
6	Item(s) Returned	
7	Serial Number(s)	
8	Reason for Return	
9	Fluid(s) Pumped	
10	Notes	

NOTE: Pump must be cleaned and neutralized prior to shipment to the factory.

Section 2: Safety Precautions

2.1 General Precautions

- **Always** lock out the power to the pump driver when performing maintenance on the pump
- **Always** lock out the suction and discharge valves when performing maintenance on the pump
- **Never** operate the pump without safety devices installed
- **Never** operate the pump with suction and/or discharge valves closed
- **Never** operate the pump out of its design specifications
- **Never** start the pump without making sure that the pump is primed
- **Never** use heat to disassemble pump
- Inspect the entire system before start-up
- Monitor the system during operation and perform maintenance periodically or as required by the application
- Decontaminate pump using procedures in accordance with federal, state, local and company environmental regulations
- Before performing maintenance on the pump, check with appropriate personnel to determine if skin, eye or lung protection is required and how best to flush the pump
- Pay special attention to all cautionary statements given in this manual.

**Caution!**

Failure to observe safety precautions can result in personal injury, equipment damage or malfunction.

Section 3: Pump & Motor Installation

3.1 Installation of Pump, Motor & Base

Refer to the Hydraulic Institute Standards for proper installation procedures of the base, pump and motor. Observe the following guidelines:

- 1) The foundation area should be rigid and level for maintaining pump alignment.
- 2) The pump and motor assembly must be securely fastened to the base, and the base must be securely attached to the ground.
- 3) The pump models covered in this manual are designed to be *long-coupled* to a motor via a mechanical coupling. To prevent excessive radial loads from being applied to the pump – which can cause vibration and lead to premature pump failure – the pump and motor shafts must be manually aligned. (Note: If the pump was delivered as a complete long-coupled assembly, it was properly aligned at the factory.) Alignment should be checked by taking measurements at the coupling. Flexible couplings are not intended to compensate for misalignment. Therefore, both angularity and parallelism should be checked and, if necessary, corrected. If these are off by more than 0.015 inches (0.4 mm), the assembly should be realigned.
- 4) The flexible insert of the mechanical coupling between the pump and motor must be free to move axially – a distance of 1/16 to 1/8 inches – to prevent axial loads from being applied to the pump.
- 5) After the pump and motor shafts have been properly aligned, install the coupling guard over the mechanical coupling and fasten to the base plate. (Note: If the pump was delivered as a complete long-coupled assembly, the coupling guard was properly installed at the factory.)

**Caution!**

Do not operate the pump unless the Coupling Guard has been properly installed on the base plate.

- 6) The pump inlet should be as close to the liquid source as practical and preferably below it.
- 7) The pump and motor should be accessible for servicing and inspection.
- 8) The pump and motor should be cleaned periodically to prevent the build-up of dust.

3.2 General Piping Requirements

Guidelines for piping are given in the Hydraulic Institute Standards and should be reviewed prior to pump installation.

- 1) All piping must be supported independently and must line up naturally with pump ports.

**Caution!**

Do not use the pump to support the piping or allow the piping to apply stress to the pump ports. This can distort the alignment of the pump housing with internal parts and lead to rapid wear or malfunction.

- 2) DO NOT make final connection of piping to pump until the grout has hardened and the pump and motor hold-down bolts have been tightened.

- 3) Piping that handles both hot and cold liquids require proper installation of expansion loops and joints so that thermal expansion of the piping will not cause misalignment.
- 4) Gasket installation and materials must be suitable for the service.
- 5) Piping runs should be designed to minimize friction losses.
- 6) Suction and discharge piping should be the same size or larger than the inlet and outlet ports.
- 7) The piping should be arranged to allow the pump to be flushed and drained prior to the removal of the pump for servicing. Valves and unions should be installed to allow the pump to be isolated during maintenance.
- 8) The piping system should be thoroughly cleaned prior to installation of the pump.

3.3 Gear Pump Requirements

- 1) A positive displacement pump should have a **pressure relief valve** installed in the discharge line. Install the relief valve between the pump discharge port and the discharge isolation valve. The relief valve should bypass the discharge line back to the supply tank, not back to the pump suction port. This is to prevent the pump from overheating should it be left running in a relieved condition.
- 2) The maximum particle size capable of being passed by the pumps is 60 microns. When pumping fluids containing suspended solids, a **filter** of at least 230 U.S. Mesh should be installed in the suction line.
- 3) Concentration of solids should be limited to 1% by volume. Exceeding this concentration can cause the wear rate to increase to an unacceptable level, resulting in a rapid decrease in pump performance. In addition to solids concentration, the specific wear rate also depends on the size, shape and hardness of the particles, the operating speed and the materials used to construct the pump.

3.4 General Motor Requirements

- 1) The motor must be compatible with the pump and conditions of the application.
- 2) The motor supply voltage must match the nameplate voltage of the motor.
- 3) The motor should never be operated outside of its design specifications.
- 4) The motor should be inspected periodically and serviced or replaced as required.



Caution!

Lock out power to the motor before servicing or replacing.

3.4.1 Motor Selection

- 1) The motor frame must be equipped with feet for mounting to a base.
- 2) The motor must have an enclosure that is compatible with the application conditions. If an explosion-proof motor is required, the *temperature code* of the motor must be acceptable for the fluid that will be pumped.

- 3) The speed and power output rating of the motor must be sufficient for the conditions of service. The power output rating of the motor should exceed the maximum power that will be required by the pump over its operating range.

3.4.2 Motor Hook-Up

- 1) Electrical wiring of the motor should be performed by a certified electrician.
- 2) Follow the recommendations of the motor manufacturer and observe all electrical wiring safety standards.
- 3) The motor supply voltage must match the motor nameplate voltage or serious motor damage or fire can result.



Caution!
Lock out power to the motor before connecting to power line.

3.4.3 Motor Direction

The motor shaft is mechanically coupled to the pump drive shaft. Both shafts will turn in the same direction. Because the gear pump is bi-directional, the pump shaft can turn in either direction to produce flow in either direction. The direction of rotation of the motor shaft (same as that of the pump drive shaft) will determine which side of the pump is the inlet (suction side) and which side is the outlet (discharge side). For the pump models covered in this manual, the flow direction will be as shown below:

Top View of Sealed Gear Pump Long-Coupled to Motor (with Transparent Coupling Guard)

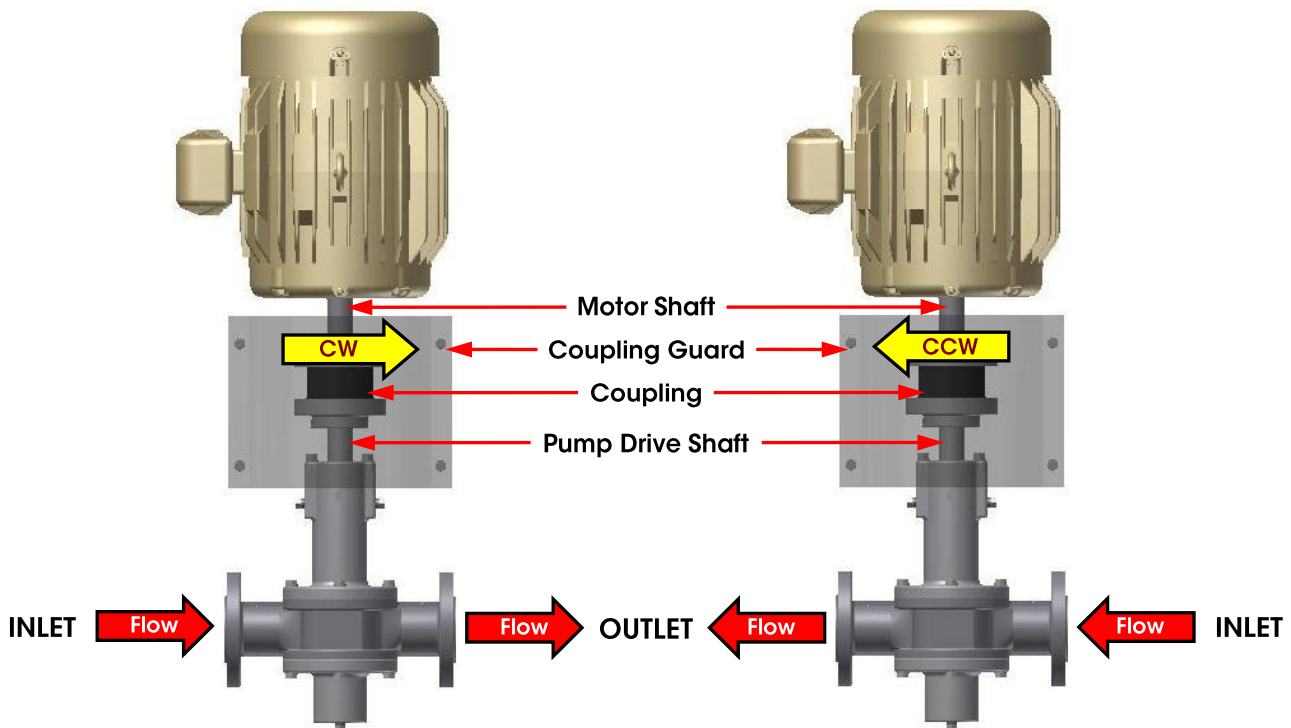

Clockwise (CW) Rotation of Motor Shaft:
Fluid will enter the pump at the left side (inlet) and be discharged at the **right** side (outlet).

Counterclockwise (CCW) Rotation of Motor Shaft:
Fluid will enter the pump at the right side (inlet) and be discharged at the **left** side (outlet).

Section 4: Start-Up & Operation

4.1 Precautions Prior to Starting Pump

- 1) Verify that the pump and motor are suitable for the conditions of service.
- 2) Verify that all suction and discharge valves are open before starting the pump.
- 3) Prime the pump and jog the motor to check the rotation. As viewed from the pump end, a clockwise rotation of the motor will result in fluid discharge to the right; counterclockwise rotation will result in fluid discharge to the left (see Page 12).
- 4) The pump is capable of pulling a dry lift, but it is still recommended that the pump be primed prior to starting.
- 5) A **pressure relief valve** should be installed in the discharge line to protect the pump and piping from any kind of line blockage including the inadvertent closing of an isolation valve.
- 6) If the fluid contains suspended solids, a **filter** of at least 230 U.S. Mesh should be installed in the suction line. Concentration of solids should be limited to 1% by volume.
- 7) Ensure that all safety devices are installed before operating pump (i.e., coupling guard, relief valve, strainer, etc.).



Caution!

Do not operate the pump unless the Coupling Guard has been properly installed on the base plate.

4.2 Operating Requirements

- 1) Do not operate the pump without fluid inside it.



Caution!

Do not run the pump dry for more than a few seconds or damage to the seal will result. Extended dry running can damage other internal parts.

- 2) The pump should be operated with at least 20 PSI (1.4 bar) differential pressure to ensure that internal components are properly lubricated by the pumped fluid.
- 3) Adequate suction pressure must be available for the pump to function properly (see NPSHR data on Page 4).
- 4) Do not operate the pump outside of its design specifications (see Pages 4 and 5).

4.3 Troubleshooting

A normally operating mechanically-sealed gear pump will deliver a steady, pulse-less flow with virtually no leakage, be relatively quiet and have a predictable flow rate based on the pump speed, fluid viscosity and differential pressure across the pump. Refer to the performance curves of the specific pump model being operated (see Liquiflo Product Catalog or website: www.liquiflo.com).

During pump operation, inspect for: (1) Unusual noise, (2) Product leakage, (3) Expected suction and discharge pressures and (4) Expected flow rate based on pump speed, fluid viscosity and differential pressure. If any problems occur, stop the pump and take corrective action. For help with problem solving, refer to the Troubleshooting Guide given in **Appendix 8**.

Section 5: Maintenance & Repair

The pump has internal bearings, wear plates, gears, shafts and a dynamic seal (i.e., mechanical seal or packing) which require replacement over time due to physical wear. The center housing of the pump may also incur physical wear and require replacement (see **Appendix 4**). O-rings and retaining rings should always be replaced when rebuilding the pump.

5.1 Work Safety

Before performing maintenance, review the safety precautions given in **Section 2** (see Page 9).

5.2 Removal from System

Before servicing, prepare the pump as follows:



Caution!

If the pump was used to move hazardous or toxic fluids, it must be flushed and decontaminated prior to removal from the system piping. Refer to the Material Safety Data Sheet (MSDS) for the liquid and follow all prescribed safety precautions and disposal procedures.

- 1 Flush the pump.
- 2 Stop the motor and lock out the electrical panel.



Caution!

Be certain the pump's motor switch is in the OFF position and the power to the motor is locked out.

- 3 Close the suction and discharge isolation valves.
- 4 Disconnect the pump from the system piping.
- 5 Disconnect the pump from the base and remove the mechanical coupling from the drive shaft.
- 6 Remove all plugs from the housing and drain the pump of any residual liquid (see photos below).

Removal of Plugs

The pump may have three to six 1/8" NPT plugs installed, depending on the seal arrangement. The pump shown at right has six plugs installed and a single internal mechanical seal.

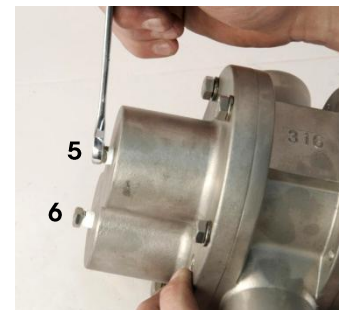

5.3 PUMP DISASSEMBLY

Follow the procedure below and refer to the drawings in **Appendix 6**.

- 1 Move the pump to a clean work area.



Caution!
The H12/312 and H14/314 pumps can weigh up to 52 lbs (24 kg) and 67 lbs (30 kg), respectively.



Removal of Seals:

- 2 The pump can have any one of four different types of seals installed. Remove the pump's seal by referring to the applicable section given below:

Section	Seal Removal	Page #	Reference Drawing	Page #
A	Packing Seal	15	Sectional #1	44
B	Single Internal Mechanical Seal	16	Sectional #2	45
C	External Mechanical Seal	16	Sectional #3	46
D	Double Mechanical Seal	17	Sectional #4	47

NOTE: If only the seal needs replacing, proceed directly to the Installation of Seals section (Pages 23 to 31) after removing the seal. If other parts need replacing, continue the disassembly procedure (see **Step 3**, Page 17).

A: Packing Removal (Refer to Sectional Drawing #1 - Page 44)

- A1 Remove the gland bolts (16) and then separate the gland plate (17) from the front housing (8).



Split Gland Plate

- A2 Extract the packing rings (18) and the lantern ring (11) from the stuffing box.



Teflon Packing Ring

NOTE: 312-314 pumps with a packing seal have a split gland plate, as shown above. H12-H14 pumps have an integral gland plate.

NOTE: The packing and lantern ring can be pulled out using a hooked tool, as shown.

B: Single Internal Mechanical Seal Removal (Refer to Sectional Drawing #2 – Page 45)

- B1** Remove two bolts (16) and then separate the gland plate (17) from the front housing (8). Separate the outer seal seat (25) from the gland plate. Remove the O-rings (10 & 18) and discard.

Gland Plate

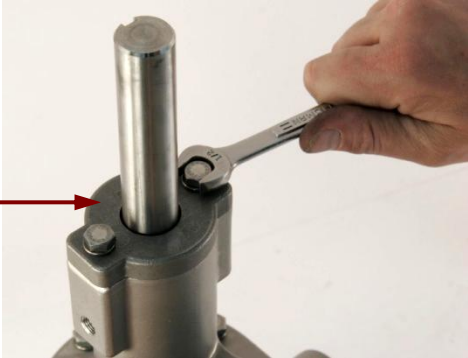

NOTE: Prior to removal or replacement of the seal, be sure to remove any burrs from the end of the drive shaft by polishing the shaft with very fine sandpaper.

- B2** Loosen all setscrews on the body of the mechanical seal (11).

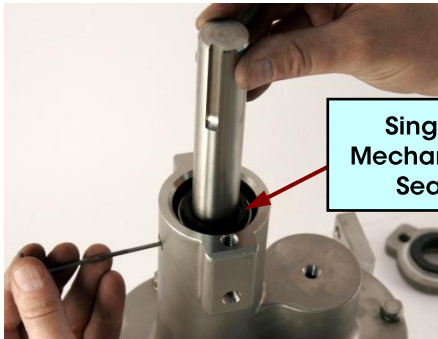

Single Mechanical Seal

NOTE: The setscrews are accessible thru the top 1/8" NPT port on the front housing. Rotate the shaft to access the setscrews.

- B3** Slide out the mechanical seal from the seal chamber.



NOTE: A small tool or Allen wrench can be used to push the seal out of the housing, as shown.

C: External Mechanical Seal Removal (Refer to Sectional Drawing #3 – Page 46)

- C1** Loosen all setscrews on the body of the mechanical seal (11).
- C2** Slide out the mechanical seal from the seal chamber.

NOTE: Prior to removal or replacement of the seal, be sure to remove any burrs from the end of the drive shaft by polishing the shaft with very fine sandpaper. The setscrews are accessible thru the top 1/8" NPT port on the front housing. A small tool or Allen wrench can be used to push the seal out of the housing. If it is necessary to replace the inner seal seat (26), it can be pressed out of the seal chamber once the front housing is separated and the bearings are removed. If the inner seal seat is removed, the seal seat O-ring (27) should be discarded.



D: Double Mechanical Seal Removal (Refer to Sectional Drawing #4 – Page 47)

- D1** Remove two bolts (16) and then separate the gland plate (17) and outer seal seat (25) from the front housing (8). Remove the O-rings (10 & 18) and discard.

Gland Plate

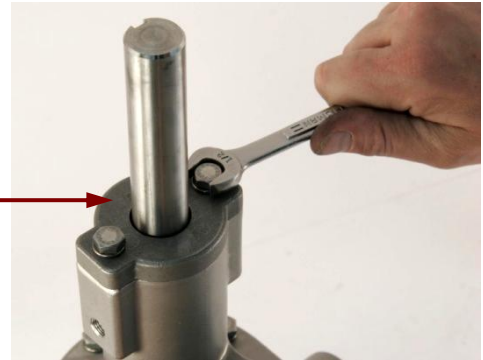

NOTE: Prior to removal or replacement of the seal, be sure to remove any burrs from the end of the drive shaft by polishing the shaft with very fine sandpaper.

- D2** Loosen all setscrews on the body of the double mechanical seal (11).

NOTE: The setscrews are accessible thru the top 1/8" NPT port on the front housing. Rotate the shaft to access the setscrews.



- D3** Slide out the mechanical seal from the seal chamber.

NOTE: A small tool or Allen wrench can be used to push the seal out of the front housing. If it is necessary to replace the inner seal seat (26), it can be pressed out of the seal chamber once the front housing is separated and the bearings are removed. If the inner seal seat is removed, the seal seat O-ring (27) should be discarded.



DISASSEMBLY CONTINUED:

- 3** Remove six housing bolts (4) from the front housing (8); then separate the front housing from the center housing (21).

Front Housing

Center Housing

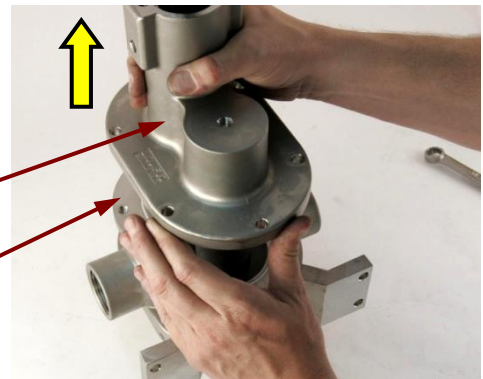

Removal of Internal Parts:

- 4** Remove the bearings (3) and lock pins (13) from the front housing (8).

NOTE: The bearings have a slip-fit design and can be extracted using a hooked tool. If the front housing has an inboard seal seat installed, it can now be pressed out using a pointed or cylindrical tool.

- 5** Remove the wear plates (7), alignment pins (12) and gear-shaft assemblies from the center-rear housing.

- 6** Remove six housing bolts (4) from the rear housing (2); then separate the rear housing from the center housing (21).

- 7** Remove the bearings (3) and lock pins (13) from the rear housing.

- 8** Remove the alignment pins (12) from the center housing.

- 9** Remove the O-rings (5) from the center housing and discard.

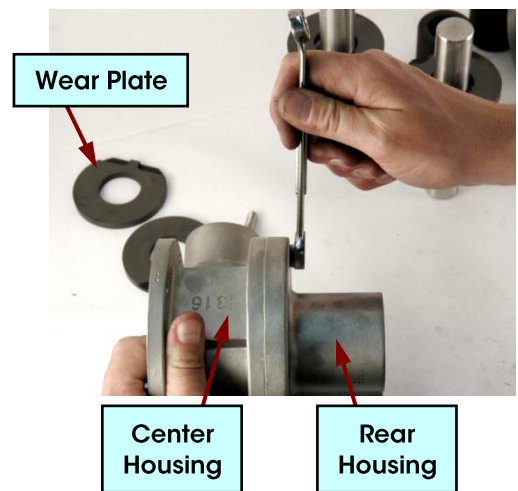
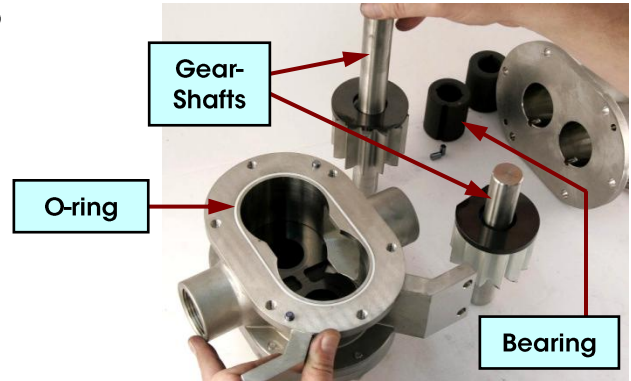
**Gear-Shaft Disassembly:**

- 10** If necessary, disassemble the gear-shafts as follows:
- a.** Remove one retaining ring (14) from the shaft (1 or 20), as shown.
 - b.** Remove the gear(s) (6 or 22) and key (24 or 23).
 - c.** Remove the remaining retaining ring (14) from the shaft (1 or 20).

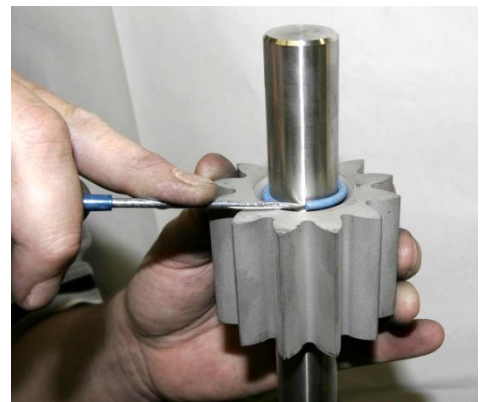

NOTE: Liquiflo Repair Kits include the gears and shafts preassembled, as shown in **Appendix 3**. If the replacement gears and shafts are not assembled, see **Appendix 5** for the assembly procedure.

NOTE: Model 314F pumps have two adjacent gears on a common shaft that are oriented with a single drive key (see Page 39). An earlier design used one key for each adjacent gear, or two keys per shaft.

END OF DISASSEMBLY PROCEDURE

5.4 PUMP ASSEMBLY

Follow the procedure below and refer to the drawings in **Appendix 6**.

Installation of Bearings into Front & Rear Housings:

- 1 Insert the bearing lock pins (13) into the front housing (8) and the rear housing (2).

NOTE: The pins serve to prevent the bearings from rotating.

NOTE: A standard rear housing (i.e., not containing a bearing flush groove) is shown at right. Housings with the Internal Bearing Flush (IBF) option are described below.

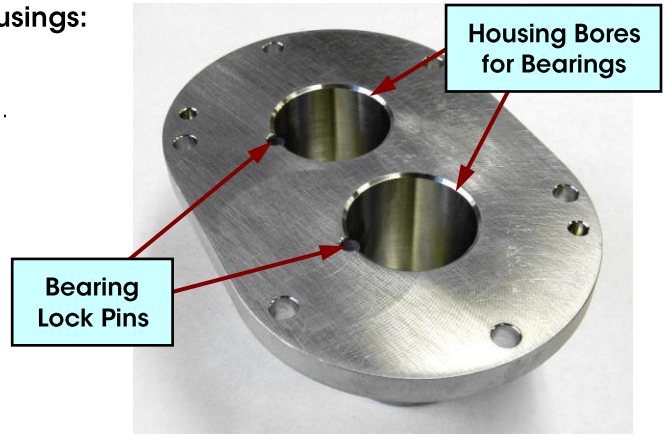

- 2 Insert the bearings (3) into the housing bores of the front and rear housings.

NOTE: Align the bearing grooves with the lock pins in the housings. The bearings have a slip-fit design and should slide easily into the housings.

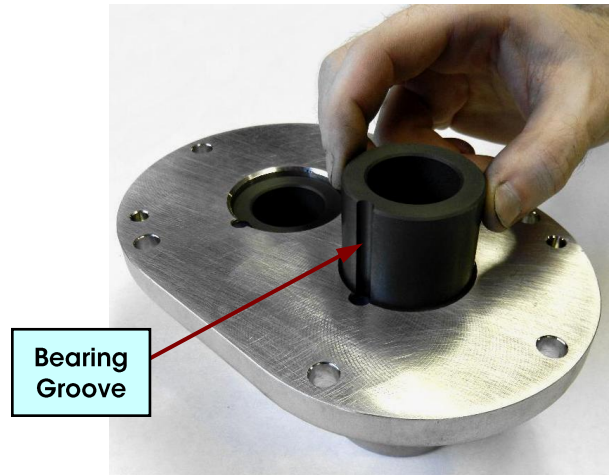

Internal Bearing Flush Option

Pumps ordered with the Internal Bearing Flush (IBF) option will have **modified front and rear housings**, as shown at right. The purpose of the IBF option is to more effectively lubricate and cool the bearings when pumping extremely thin or extremely thick liquids. When assembling the pump, the IBF grooves must be oriented on the higher pressure discharge side of the pump.

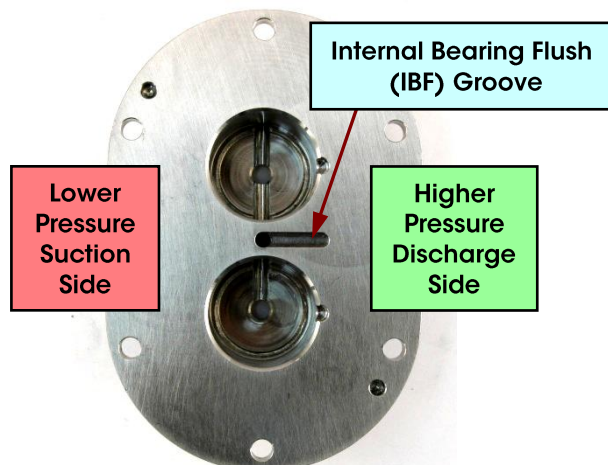

- 3** Insert two housing alignment pins (12) into the rear housing (2).

NOTE: The pins should have a slip fit into the housing. The pump will be assembled in a vertical orientation starting with the rear housing. The 1/8" NPT plugs should not be installed into the rear housing at this time. This will allow the rear housing to lie flat on the bench surface.

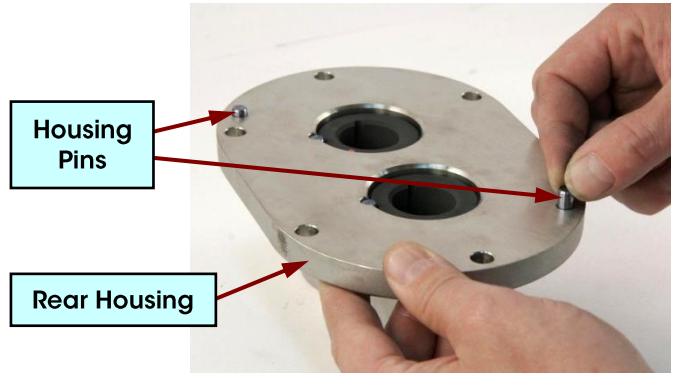

- 4** Install one O-ring (5) into the racetrack shaped groove of the center housing (21).

Caution!
Do not reuse O-rings.

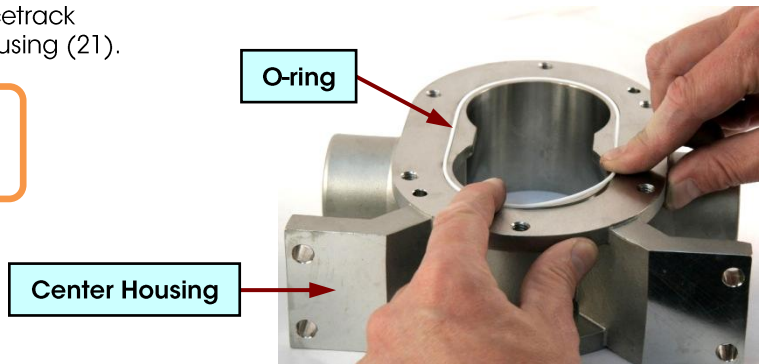

- 5** Place the center housing (21) into position on top of the rear housing (2), as shown.

NOTE: Make certain the O-ring is facing down and the center housing seats properly over the alignment pins in the rear housing.



- 6** Install six housing bolts (14) with lock-washers (15); then tighten the bolts.

NOTE: Apply anti-seize compound to the bolts. Refer to **Appendix 1** for the torque specifications of the fasteners. When tightening the housing bolts, use a star pattern torque sequence on the fasteners to ensure even compression on the O-ring's surface. With Teflon (PTFE) O-rings, repeat this process several times, waiting between retightening. This is necessary because Teflon will cold flow and require a certain amount of time to properly seat. Continue the process until the bolts no longer require retightening.

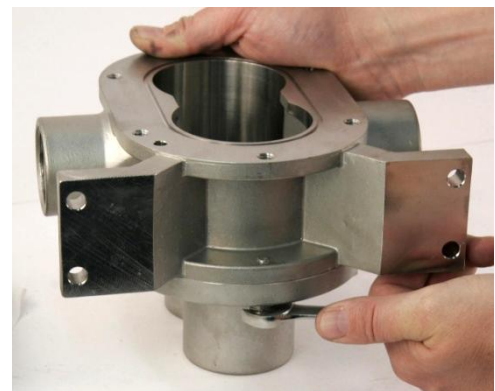

Installation of Wear Plates

Standard Liquiflo wear plates are manufactured with cut-outs or grooves to provide liquid relief paths to reduce hydraulically-induced gear separation forces that exist during pump operation. These forces decrease pump life by placing significant loads on the shafts and bearings. To be effective, the relief grooves must face toward the gears.

NOTE: Failure to orient the wear plates properly will reduce the operating life of the pump.

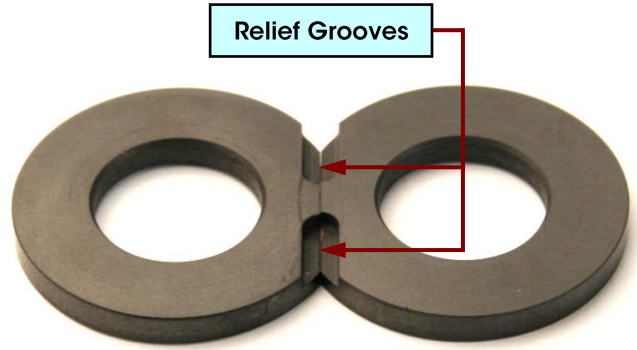

- 7 Place two wear plates (7) into position inside the housing bores, as shown.

NOTE: For relieved wear plates, the cut-outs must face up (see photo). This will orient the relief grooves toward the gears.

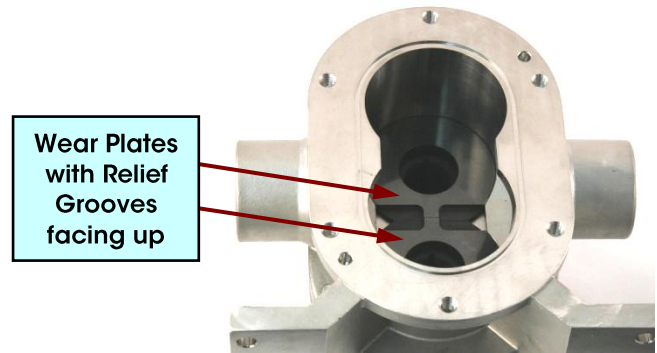

Installation of Gear-Shaft Assemblies:

- 8 Insert the gear-shaft assemblies into the housing, as shown.

NOTE: Liquiflo Repair Kits contain the gears and shafts preassembled, as shown to the right and in **Appendix 3**. If the replacement gears and shafts are not assembled, see **Appendix 5** for the assembly procedure.

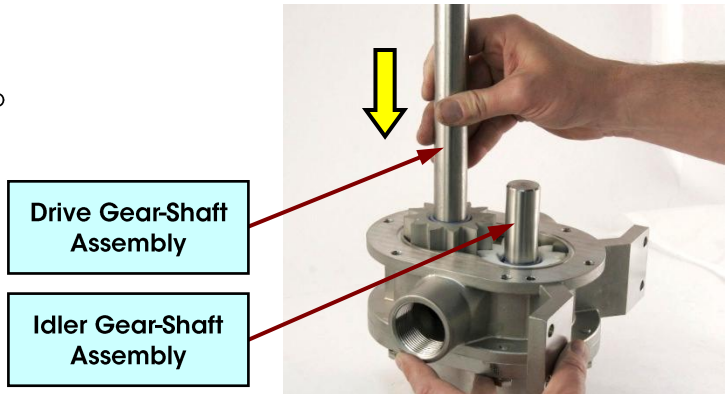

- 9 Place two wear plates (7) into position on top of the gears, as shown.

NOTE: For relieved wear plates, the cut-outs must face down, toward the gears.

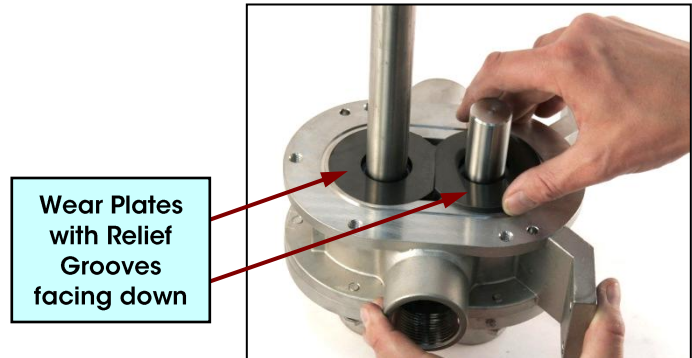

- 10** Install O-ring (5) into the racetrack shaped groove of the center housing (21).

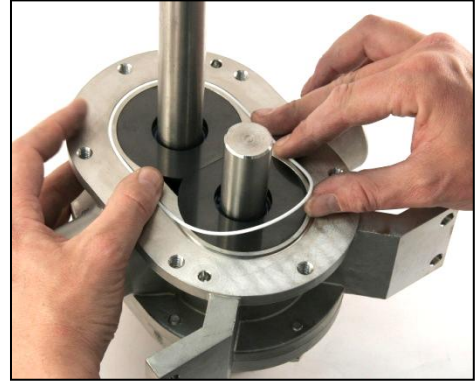

- 11** Insert two housing alignment pins (12) into the center housing (21), as shown.

NOTE: The pins should have a slip fit into the housing. The housing pins serve to accurately align the front, center and rear housings.

Housing Pins

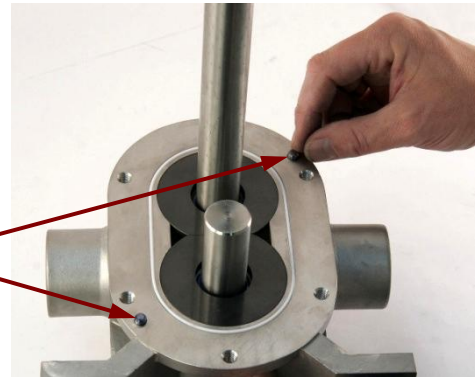

- 12** Install the front housing (8) to the center housing (21), as shown.

NOTE: The front housing should be installed to the center housing horizontally to ensure that the bearings will not slide out of the front housing. Be certain the front housing seats properly over the alignment pins in the center housing. If the pump has an IBF option, the IBF grooves in the front and rear housings must be oriented on the discharge side of the pump (see Page 19).

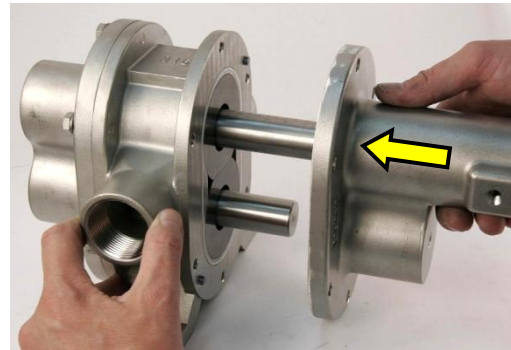

- 13** Install six housing bolts (4) with lock-washers (15); then tighten the bolts.

NOTE: Apply anti-seize compound to the bolts. Refer to **Appendix 1** for the torque specifications of the fasteners. When tightening the housing bolts, use a star pattern torque sequence on the fasteners to ensure even compression on the O-ring's surface. With Teflon (PTFE) O-rings, repeat this process several times, waiting between retightening. This is necessary because Teflon will cold flow and require a certain amount of time to properly seat. Continue the process until the bolts no longer require retightening.

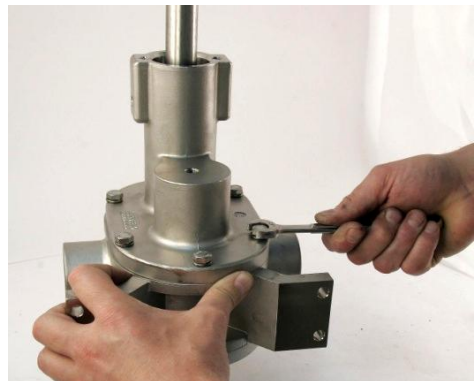

- 14** Turn the drive shaft (20) by hand to ensure that the gears will rotate freely inside the housing.

NOTE: During this check, the gears can be viewed through the pump ports.

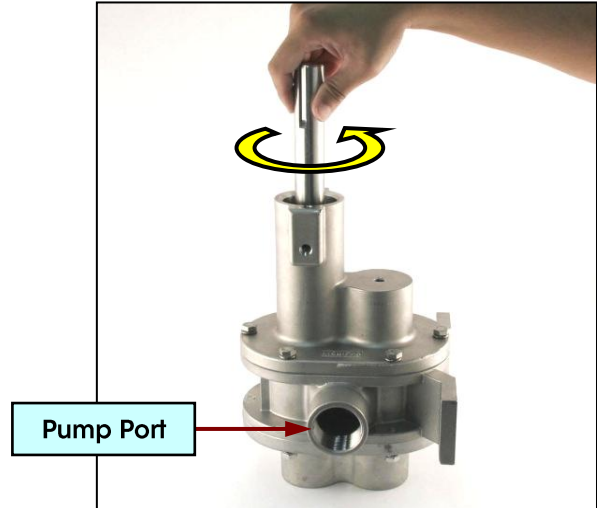

Installation of Seals:

- 15** The pump can have any one of four different types of seals installed. Install the appropriate seal by referring to the applicable section given in the table below:

Section	Seal Installation	Page #(s)	Reference Drawing	Page #
A	Packing Seal	23-24	Sectional #1	44
B	Single Internal Mechanical Seal	25-27	Sectional #2	45
C	External Mechanical Seal	28	Sectional #3	46
D	Double Mechanical Seal	29-31	Sectional #4	47

A: Packing Installation (Refer to Sectional Drawing #1 – Page 44)

Packing

The “stuffing box” section of the pump’s front housing requires five rings of packing and a lantern ring, positioned as shown in Sectional Drawing #1. The lantern ring allows grease or flush fluid to enter the pump and lubricate the packing. The standard packing material is braided Teflon, which is suitable for application temperatures up to 350°F. Above 350°F, Graphoil packing should be used.

The Teflon packing used in Liquiflo pumps has a split-ring design. Adjacent rings should be staggered by 180° to increase performance and minimize leakage. Graphoil packing has a solid-ring design and therefore does not require staggering.

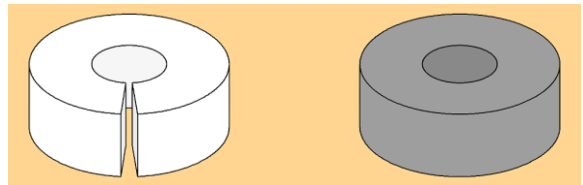

Teflon Packing Ring

Graphoil Packing Ring

A1 Insert **three** packing rings (18) into the front housing (8).

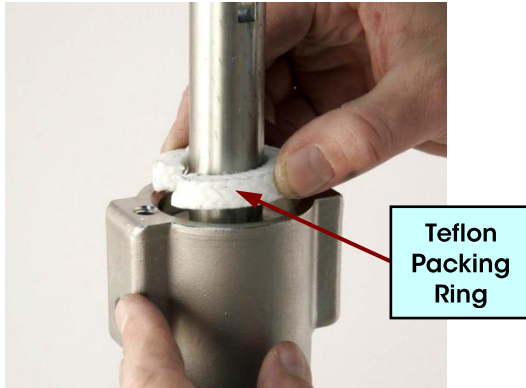

NOTE: Be sure to stagger the splits in adjacent rings 180° apart.

A2 Install the lantern ring (11).



A3 Install **two** additional packing rings (18) into the front housing; then install the gland plate (17) using two bolts (16). Loosely bolt the gland plate into position.



NOTE: 312-314 pumps with a packing seal have a split gland plate, as shown above. H12-H14 pumps have an integral gland plate.

Caution!
Do not over-tighten the gland screws. Tighten by hand only.



NOTE: Stagger the splits in the rings by 180°. The packing compression must be adjusted during pump operation (see **Appendix 7**).

A4 Install grease fitting (25) into either side of the front housing (8); then install a total of **five** plugs (9) into the remaining 1/8" NPT ports.

NOTE: Prior to installation, apply Teflon tape or pipe lubricant to the threads of the fitting and plugs, to prevent leakage and galling. The grease fitting should be in alignment with the lantern ring inside the seal chamber. Three plugs go into the front housing and two plugs go into the rear housing.

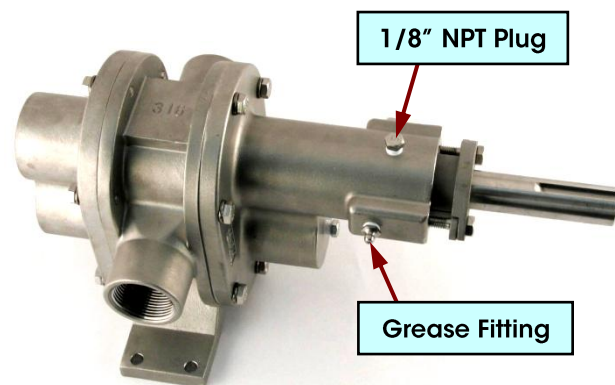

Model 312 Pump shown with Packing Seal and NPT Ports

Precautions for Installation of Mechanical Seals (Applicable to Sections B, C & D)

- 1 If the drive shaft exhibits excessive wear, the shaft must be replaced.
- 2 Remove all burrs, scratch marks or high spots from the drive shaft before installing the mechanical seal. This will prevent damaging the seal wedge during installation of the seal. Damage to the seal wedge can cause the seal to leak.
- 3 Do not scratch or handle the lapped face of the seal.
- 4 A new mechanical seal is supplied with retaining clips covered by tape. The clips compress the seal springs, eliminating spring pressure on the seal wedge. To ease installation and to prevent damaging the wedge, do not remove the clips until after the seal is installed on the shaft. Once the clips are removed, the spring pressure will cause the wedge to seal against the shaft.
- 5 Do not reuse seal seat O-rings.

B: Single Internal Mechanical Seal Installation (Refer to Sectional Drawing #2 – Page 45)

B1



Caution!

Remove all burrs, scratches and high spots from the drive shaft prior to installation of the mechanical seal. Do not remove the retaining clips from the seal until after the seal is installed on the shaft.

Slide the mechanical seal (11) on the drive shaft (20) with the seal face directed away from the housing, as shown; then remove the tape and retaining clips from the seal.



B2 Install O-ring (18) onto outer seal seat (25); then lubricate the O-ring.



Caution!

Do not reuse O-rings.

O-ring



NOTE: Use a lubricant that is compatible with the elastomer and fluid that will be pumped.

- B3** Insert outer seal seat (25) into the gland plate (17).

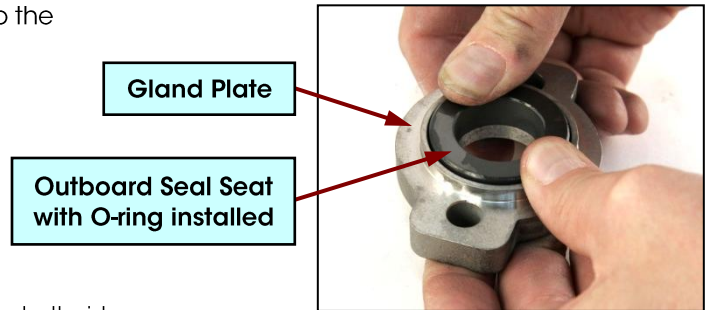

NOTE: The outboard seal seat is lapped on both sides so orientation into the gland plate does not matter.

- B4** Install the gland plate O-ring (10).

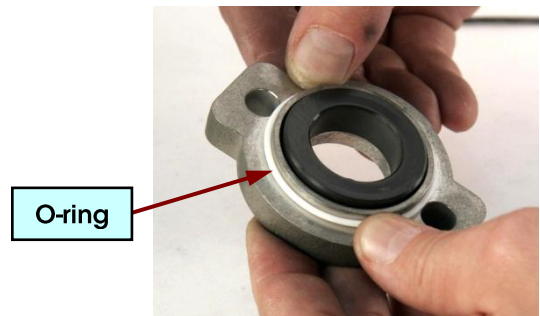

- B5** Push the mechanical seal (11) into the seal chamber and position the seal so that the setscrews are accessible thru the 1/8" NPT port on the top of the front housing (8).

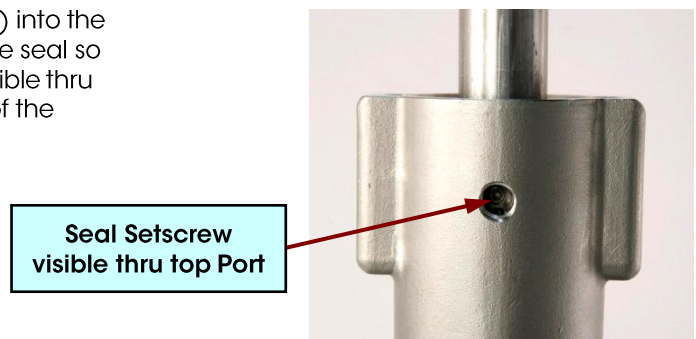

- B6** Lightly tighten one setscrew on the seal body; then test the seal compression by pressing the seal seat inside the gland plate against the seal face inside the front housing. **The compression gap should be approximately 1/16" (1.6 mm).** If necessary, loosen the setscrew and reposition the seal on the drive shaft to attain the proper compression distance.

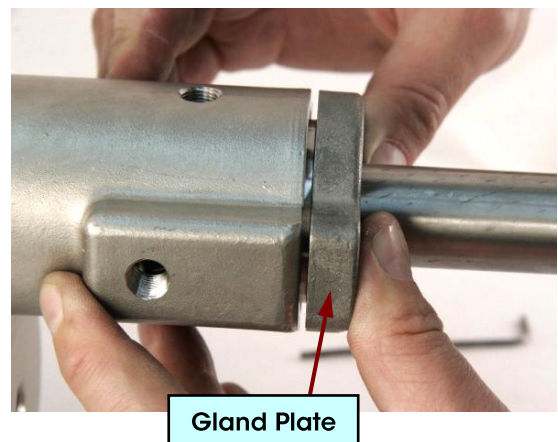

B7 After the mechanical seal is properly positioned on the drive shaft, tighten **all** setscrews on the seal body.

NOTE: Rotate the shaft in steps to access each setscrew thru the top 1/8" NPT port.



B8 Install the gland plate (17) to the front housing (8) using two sets of bolts (16) and lockwashers (19).

NOTE: See **Appendix 1** for the torque specifications of the gland bolts

Gland Bolt
Lockwasher

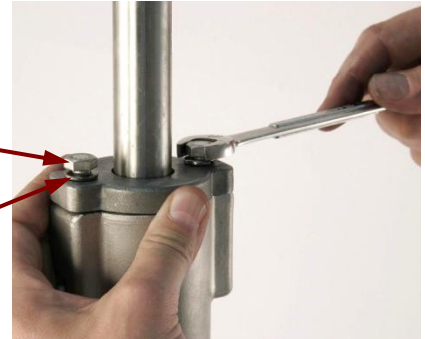

B9 Install **four** 1/8" NPT plugs (9) into the front housing (8).



B10 Install **two** 1/8" NPT plugs (9) into the rear housing (2).



NOTE: Prior to installation, apply Teflon tape or pipe lubricant to the threads of all plugs, to prevent leakage and galling.

**Model 312 Pump shown with
Single Internal Mechanical Seal
and NPT Ports**

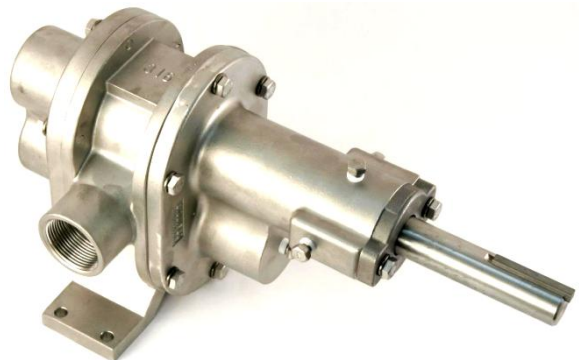

C: External Mechanical Seal Installation (Refer to Sectional Drawing #3 – Page 46)

C1 Install O-ring (27) onto inner seal seat (26); then lubricate the O-ring.



Caution!
Do not reuse O-rings.



O-ring



NOTE: Use a lubricant that is compatible with the elastomer and fluid that will be pumped.



Caution!
Remove all burrs, scratches and high spots from the drive shaft prior to installation of the mechanical seal. Do not remove the retaining clips from the seal until after the seal is installed on the shaft.

C2 Slide the seal seat (26) over the drive shaft (20) and then carefully press it into place inside the front housing (8).

C3 Slide the mechanical seal (11) on the drive shaft (20); then remove tape and retaining clips.



Inboard Seal Seat with O-ring installed and lapped surface facing up



Caution!
The lapped surface of the of the Seal Seat must face the Mechanical Seal.

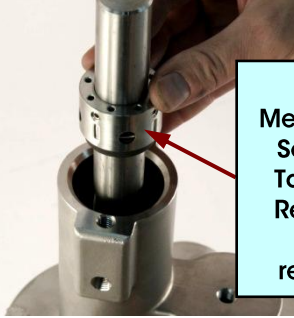

Single Mechanical Seal with Tape and Retaining Clips removed

NOTE: A rigid plastic tube can be used to press the seal seat into position inside the housing.

NOTE: The seal face of the mechanical seal must face towards the seal seat, as shown.

C4 Compress the mechanical seal against the seal seat by **approximately 1/16" (1.6 mm)**; then tighten **all** mechanical seal setscrews.

C5 Install **two** plugs (9) into the rear housing (2) and **one** plug into the front housing (8).

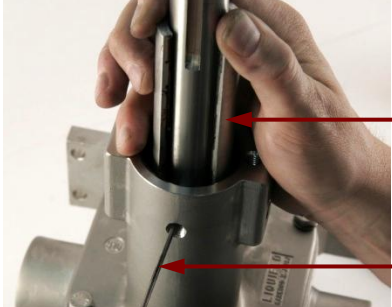

Tube for compressing Mechanical Seal

Allen Wrench

NOTE: The seal can be compressed with a rigid tube, as shown above.



NOTE: Apply Teflon tape or pipe lubricant to threads of all plugs prior to installation.

D: Double Mechanical Seal Installation (Refer to Sectional Drawing #4 – Page 47)

D1 Install O-ring (27) onto inner seal seat (26); then lubricate the O-ring.

 **Caution!**
Do not reuse O-rings.

NOTE: Use a lubricant that is compatible with the elastomer and fluid that will be pumped.

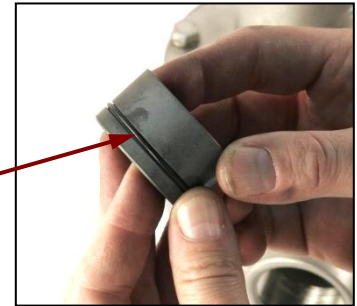

D2 Slide the inner seal seat (26) over the drive shaft (20) and then carefully press it into place inside the front housing (8).

 **Caution!**
The lapped surface of the Seal Seat must face the Mechanical Seal.

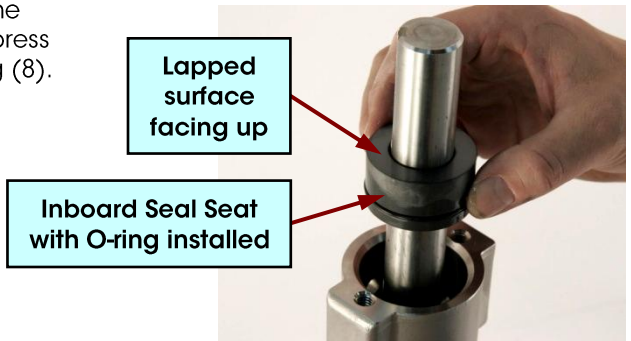

NOTE: The lapped (polished) surface of the inboard seal seat must be directed upward, as shown. A rigid plastic tube can be used to press the seal seat into position inside the seal chamber.

D3 Install O-ring (18) onto outer seal seat (25); then lubricate the O-ring.

 **Caution!**
Do not reuse O-rings.

NOTE: Use a lubricant that is compatible with the elastomer and fluid that will be pumped.



D4 Insert outer seal seat (25) into the gland plate (17).

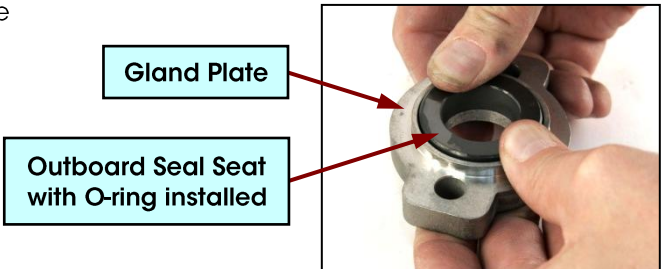



NOTE: The outboard seal seat is lapped on both sides so orientation into the gland plate does not matter.

D5 Install the gland plate O-ring (10).

 **Caution!**
Do not reuse O-rings.

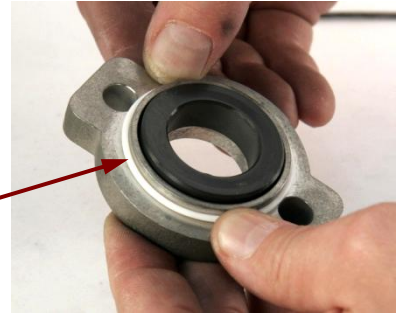
O-ring



 **Caution!**
Remove all burrs, scratches and high spots from the drive shaft prior to installation of the mechanical seal. Do not remove the retaining clips from the seal until after the seal is installed on the shaft.

D6 Slide the double mechanical seal (11) on the drive shaft (20); then remove the tape and retaining clips.



Double Mechanical Seal



NOTE: The double mechanical seal is symmetrical, so the seal faces can be oriented either way.

D7 Slide the double mechanical seal into the seal chamber and position the seal so that the setscrews are accessible thru the 1/8" NPT port on the top of the front housing (8).

Seal Setscrew
visible thru top Port

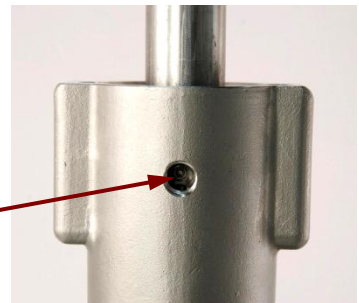

D8 Install the gland plate (17) to the front housing using two bolts (16) with lockwashers (19).

NOTE: Be certain the gland plate has the seal seat and O-ring installed. The double mechanical seal will self-position once the gland plate is installed. See **Appendix 1** for the torque specifications of the gland bolts.

Gland Plate

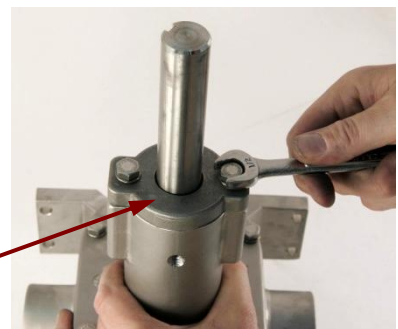

D9 Tighten **all** setscrews on the body of the double mechanical seal (11).

NOTE: Rotate the shaft in steps to access each setscrew thru the top 1/8" NPT port.



D10 Install **two** 1/8" NPT plugs (9) into the top and bottom of front housing (8).

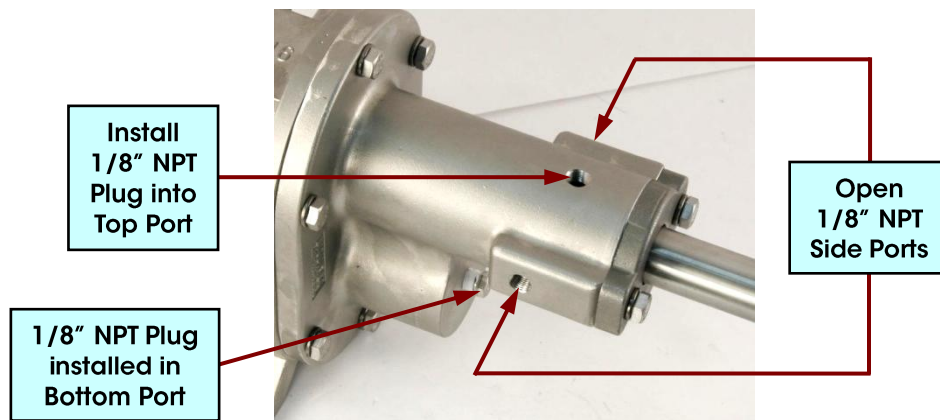

NOTE: Prior to installation, apply Teflon tape or pipe lubricant to the threads of the plugs, to prevent leakage and galling. The two 1/8" NPT ports on the sides of the front housing must be connected to the *barrier fluid lubrication system* for supporting the double mechanical seal during pump operation (see **Appendix 7**).



Caution!

Failure to properly support the double mechanical seal during pump operation will result in premature seal wear and leakage.

D11 Install **two** 1/8" NPT plugs (9) into the rear housing (2), as shown.

NOTE: Prior to installation, apply Teflon tape or pipe lubricant to the threads of the plugs.

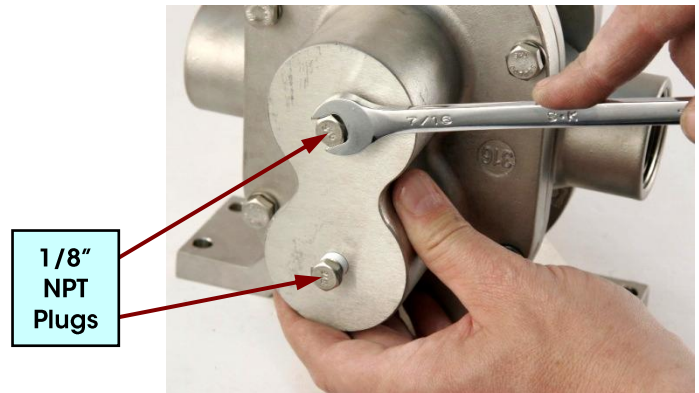

END OF ASSEMBLY PROCEDURE

Appendix 1: Fastener Torque Specifications

Maximum Torque Specifications for 18-8 Stainless Steel Bolts





Function	Bolt Size	Bolt Type	Quantity (per Pump)	Max Torque Specifications	
				(in-lbs)	(N-m)
Housing Assembly	5/16-18 UNC x 1	HHCS	12	132	14.9
Gland Plate Assembly - Packing	5/16-18 UNC x 1 ¼	HHCS	2	132	14.9
Gland Plate Assembly - Mech. Seals *	5/16-18 UNC x 1	HHCS	2	132	14.9

* Not applicable for pumps with External Mechanical Seal.

HHCS = Hex Head Cap Screw

Appendix 2: Maintenance Tool List







The following tools (or equivalents) are required when performing maintenance on the pumps:

Tool #	Tool	Function	Photo
1	Wrench, 1/2"	For pump housing bolts and gland plate bolts.	
2	Wrench, 7/16"	For 1/8" NPT plugs and grease fitting.	
3	Allen Wrench, 3/32" Hex	For mechanical seal setscrews.	
4	Pointed & Hooked Tool	Pointed: For removal of retaining rings from drive and idler shafts. Hooked: For removal of bearings from front and rear housings, and packing rings from front housing.	
5	Rubber Mallet *	For installation of retaining rings on drive and idler shafts.	

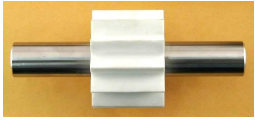
* Required for gear-shaft assembly (see **Appendix 5**).



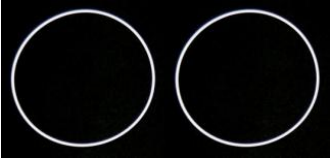



Appendix 3: Repair Kits

The following components are included in a standard Liquiflo Sealed Pump Repair Kit:

Item #	Repair Kit Component	Quantity	Photo
1	Drive Gear-Shaft Assembly	1 (Includes Gear, Drive Shaft, Key & 2 Retaining Rings)	
2	Idler Gear-Shaft Assembly	1 (Includes Gear, Idler Shaft, Key & 2 Retaining Rings)	
3	Wear Plates (Relieved Type)	4	
4	Bearings (Sleeve Type)	4	
5	Pins, Bearing Lock	4	
6	Pins, Housing Alignment	4	
7	O-rings, Housing (2-047)	2	
8	O-ring, Gland Plate (2-032) *	1	

* Not applicable for pumps with External Mechanical Seal.

Appendix 3: Repair Kits (Continued)

Item #	Repair Kit Component	Quantity	Photo	
			Single Seal **	Double Seal
9	Mechanical Seal	1 (Single or Double Mechanical Seal)		
	or Packing Rings	5		
10	Seal Seat, Outer with O-ring (2-222)	1 (Included with Single Internal or Double Mechanical Seals only)		
11	Seal Seat, Inner with O-ring (2-030)	1 (Included with External or Double Mechanical Seals only)		

** Includes Single Internal and External Mechanical Seals.

NOTE: To order a Repair Kit for an existing Sealed pump, simply place a "K" in front of the Pump's Model Number to designate the **Kit Order Number**. Example: **KH12FS6PEEU120061**. Using this ordering number will ensure that the kit component materials will match those used in the pump.

Appendix 4: Wear Allowances

When a pump requires maintenance, a convenient way to restore the pump to like-new condition is to use a repair kit. The repair kit contains all *internal wear parts* as well as O-rings, retaining rings, bearing lock pins, housing alignment pins and keys.

In some cases, only certain parts may need to be replaced. The primary wear parts of the pump are the gears, shafts, wear plates and bearings. The center housing (secondary wear part) may also incur physical wear by contact with the gears caused by excessively worn bearings. (Note: the center housing is not included in a standard repair kit.) These wear parts can be reused if they are in acceptable condition. O-rings and retaining rings should not be reused. The following used parts should be inspected and evaluated for reuse based on the specifications given in the **Wear Allowances Chart** (see Page 38):

Gears: Spur gears should have a uniform tooth profile on both the leading and trailing edges. If the outer diameter of the gear is worn, pumping performance will degrade. Gears with minor wear should be evaluated for reuse by measuring the outer diameter and comparing it to the minimum diameter specification given in the Wear Allowances Chart. Gears with obvious major wear, such as flattened teeth or other significant wear on the profile, should be replaced (see photo at right).

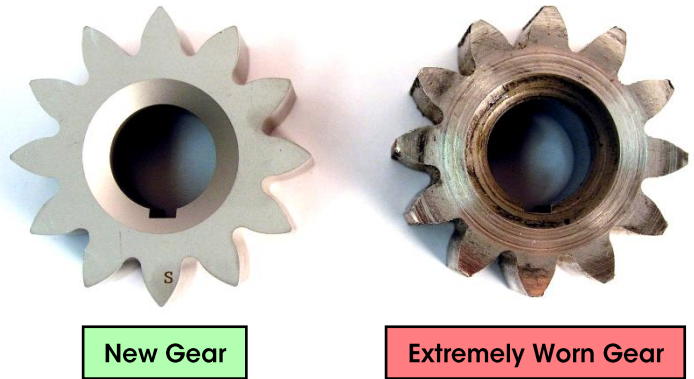

Shafts: The area of the shaft that is engaged in the bearings will wear over time depending on the service conditions and the materials of construction (see photo below). Hard-coated shafts are available to minimize or eliminate wear of the shaft surfaces. Worn shafts may allow the gears to contact the center housing and accelerate both gear and center housing wear. The shaft journal area should be round and have a minimum diameter as specified in the Wear Allowances Chart.

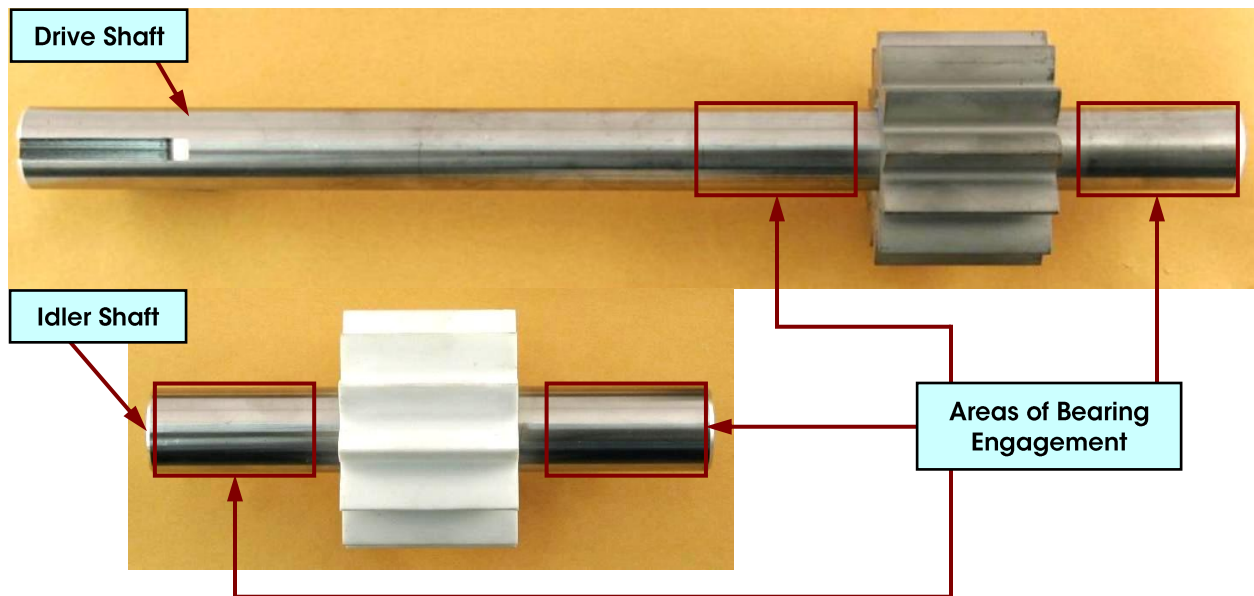

Appendix 4: Wear Allowances (Continued)

Wear Plates: This is a sacrificial part of the pump designed to protect the front and rear housings from wear by continual contact with the sides of the gears. Erosion of the wear plates increase clearances causing slip to increase. This results in a reduction in pump performance. Wear plates should have smooth surfaces and meet the minimum thickness requirements given in the Wear Allowances Chart. (Note: Standard Liquiflo wear plates are manufactured with cut-outs or relief grooves to minimize hydraulically-induced gear separation forces. These *relieved wear plates* increase pump life by reducing loads on bearings and shafts. A typical relieved wear plate is shown at right.)

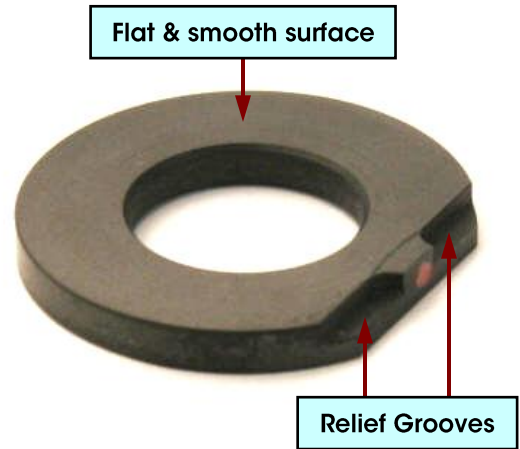

Bearings: The H-Series pumps use sleeve-type bearings that are also known as *journal bearings*. These bearings are designed to support the shafts and precisely position the gears inside the housing. Worn bearings will eventually allow the rotating gears to contact the center housing, causing wear and eventual failure of both of these components. (The typical wear mechanism of the bearings is described below.) If any wear of the bearings is observed, they should be replaced. The Wear Allowances Chart gives the maximum inner diameter that is acceptable for worn bearings.

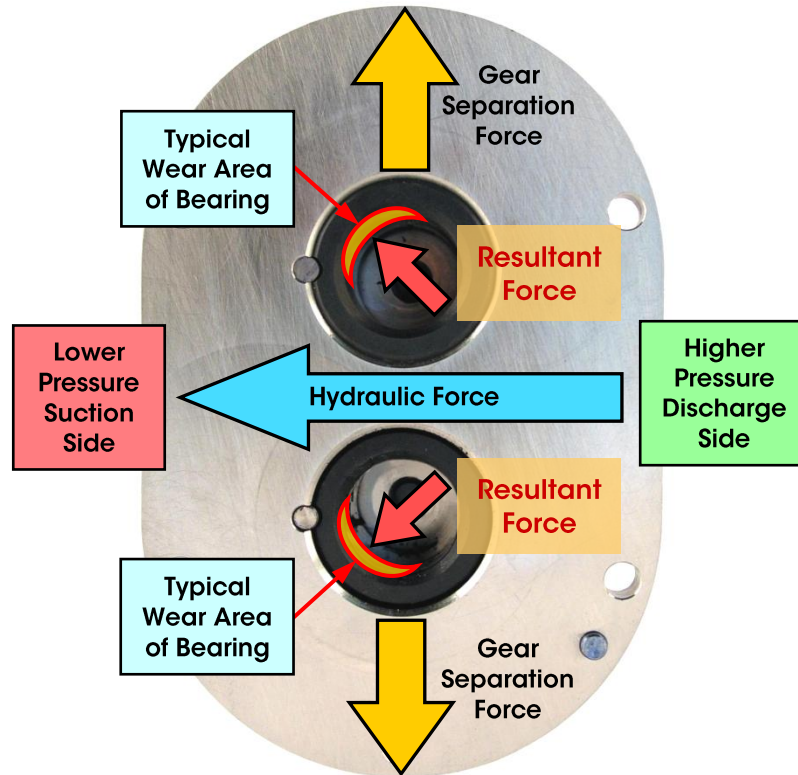

Typical Wear Mechanism of Bearings

Appendix 4: Wear Allowances (Continued)

Center Housing: The typical failure mode for the center housing is from contact with the rotating gears, caused by extreme wear of the bearings and shafts. Evidence of contact or slight wear on the inside surfaces can be expected. However, if deep grooves or excessive wear is observed, the center housing should be replaced. (See photo below for the typical wear areas of the center housing.) Reusing an excessively worn center housing in a rebuilt pump will cause the pump performance to be lower than expected because of increased slip.

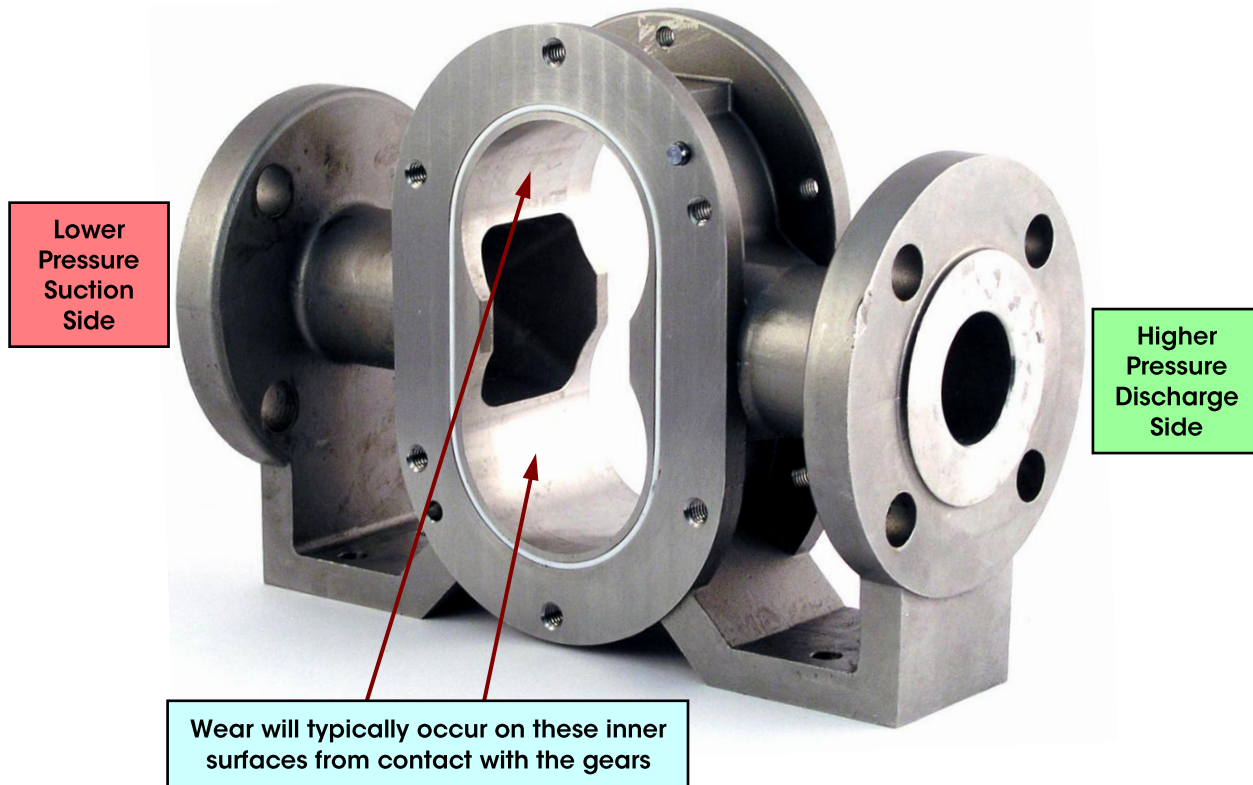

Wear Allowances Chart (Units: inches)

Pump Series	Pump Model	Gears		Shafts		Wear Plates		Bearings	
		Nom. O.D.	Min O.D.	Nom. O.D.	Min O.D.	Nom. Thick.	Min Thick.	Nom. I.D.	Max I.D.
H-Series	H12R	2.790	2.781	1.125	1.122	0.500	0.496	1.125	1.128
	H12F	2.790	2.781	1.125	1.122	0.250	0.246	1.125	1.128
	H14F	2.790	2.781	1.250	1.247	0.250	0.246	1.250	1.253
3-Series	312R	2.790	2.781	1.000	0.997	0.500	0.496	1.000	1.003
	312F	2.790	2.781	1.000	0.997	0.250	0.246	1.000	1.003
	314F	2.790	2.781	1.000	0.997	0.250	0.246	1.000	1.003

O.D. = Outer Diameter

I.D. = Inner Diameter

NOTE: All diameter values listed in the above table are based on standard (untrimmed) parts. Parts requiring viscosity or temperature trims will have dimensions based on the application. Consult factory.

Appendix 5: Gear-Shaft Assembly

Parts List for Gear-Shaft Assemblies

Drive Gear-Shaft Parts			Idler Gear-Shaft Parts		
Part	Quantity		Part	Quantity	
	Models H12-H14 & 312	Model 314F		Models H12-H14 & 312	Model 314F
Drive Gear	1	2	Idler Gear	1	2
Drive Shaft	1	1	Idler Shaft	1	1
Key	1	1 *	Key	1	1 *
Retaining Ring	2	2	Retaining Ring	2	2

* Former design used two keys per shaft.

Gear-Shaft Assembly Parts for Model 312F:

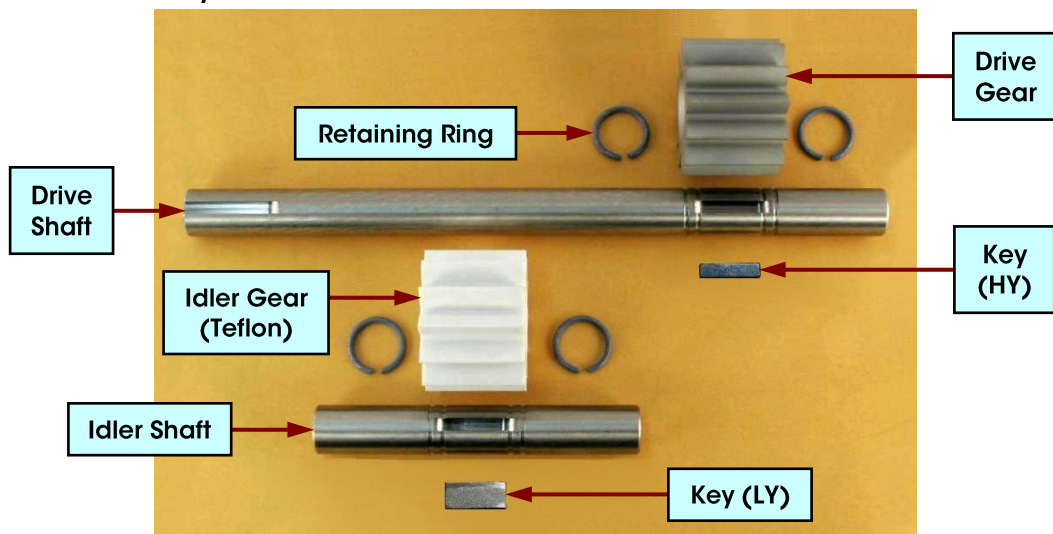

Gear-Shaft Assembly Parts for Model 314F:

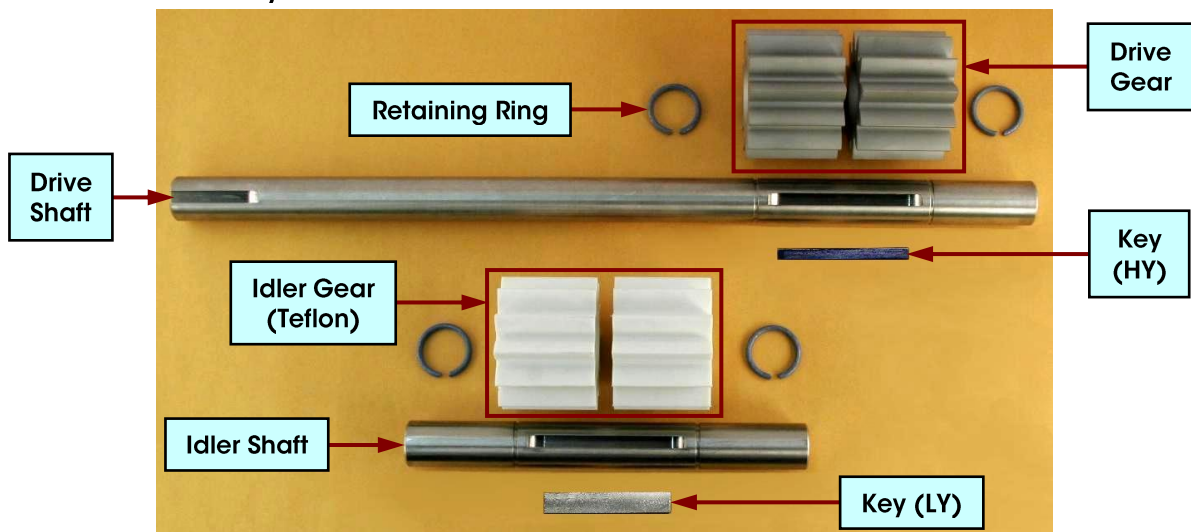

NOTE: The Model 314F gears are comprised of two Model 312F gears, as shown above. The Model H14F gears are a single-piece design with the same Outer Diameter and Length as the two-piece Model 314F gear (see chart at top of Page 41).

Appendix 5: Gear-Shaft Assembly (Continued)

Description of Parts:

Shafts: The pump contains two kinds of shafts: the *drive shaft* and the *idler shaft*. Both shafts have retaining ring grooves and a keyway for positioning the gears. The drive shaft also has a keyway on one end for installing the mechanical coupling. The shafts for Models H12 and 312 have two sets of retaining ring grooves to position either full (F) or reduced (R) size gears (see **Diagram 1**). The shafts for Model H14F and 314F have one set of grooves. The chart at the top of Page 41 can be used to identify the shafts.

Diagram 1 - Drive and Idler Shafts

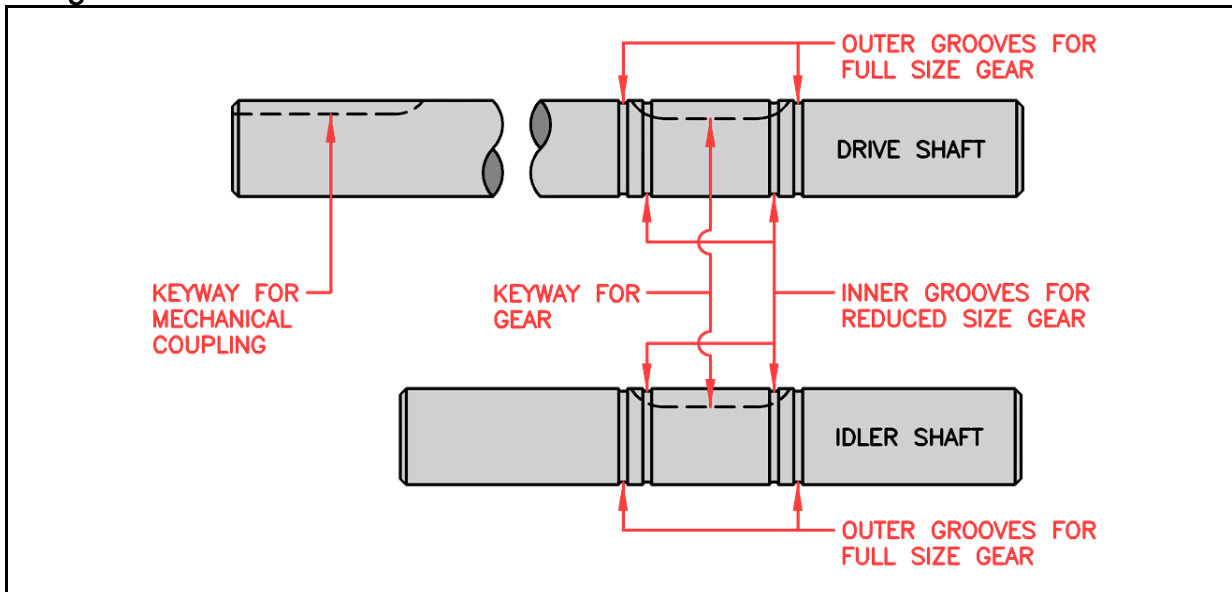

Gears: The H-Series and 3-Series pumps use spur style gears as shown in **Diagram 2**. To identify the gears, use the chart at the top of Page 41.

Diagram 2 - Spur Gear

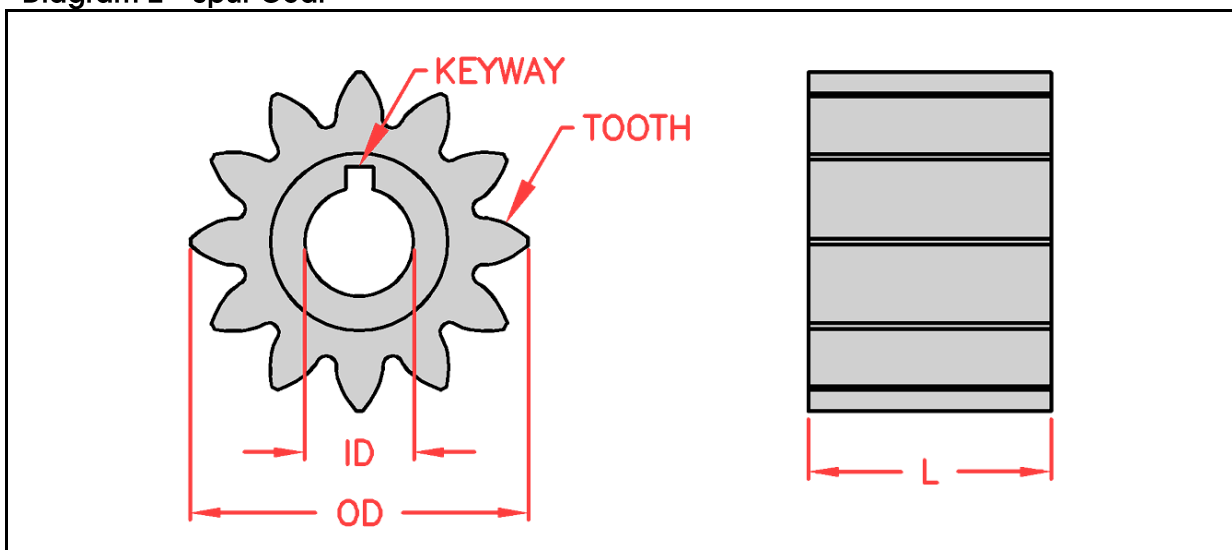

Appendix 5: Gear-Shaft Assembly (Continued)

Gear & Shaft Identification Chart (Units: inches)

Part	Part Dimension	Pump Models					
		H12R	H12F	H14F	312R	312F	314F
Gear (Drive or Idler)	Outer Diameter (OD)	2.79	2.79	2.79	2.79	2.79	2.79
	Inner Diameter (ID)	1-1/8	1-1/8	1-1/4	1	1	1
	Length (L)	1.50	2.00	4.00	1.50	2.00	4.00*
	# of Teeth	12	12	12	12	12	12
Drive Shaft	Diameter	1-1/8		1-1/4**	1		1
	Length	13.00		14.20	14.50		19.00
	# of Ref. Ring Grooves	4		2	4		2
Idler Shaft	Diameter	1-1/8		1-1/4	1		1
	Length	6.50		8.50	6.50		8.50
	# of Ref. Ring Grooves	4		2	4		2

* Two Model 312F gears. **Coupling end diameter is 1-1/8.

Keys: Two types of gear keys are used in the pumps: High-yield (HY) and low-yield (LY). HY and LY keys are used for the Model 312 and 314 pumps. H-Series pumps use only HY keys. In the 3-Series pumps, HY keys are used for all gear materials except Teflon; LY keys are used only for Teflon gears. (Note: HY keys have a lower height than LY keys.) To identify the keys, use the following chart:

Key Identification Chart	NOTE: Key profiles are shown in actual size.
 H12R & H12F 312R & 312F (HY)	 H14F 314F (HY)
 312R & 312F (LY)	 314F (LY)

Retaining Rings: The retaining rings are used to position the gears on the shafts. They should always be replaced when repairing the pump. (The retaining rings for the pumps are shown at right in actual size.)



Appendix 5: Gear-Shaft Assembly (Continued)

Gear-Shaft Assembly Procedure:



Caution!

Be careful not to damage the shafts.

- 1 Place the first retaining ring (4) on a firm but soft surface and then place the shaft (1 or 20) over the retaining ring, as shown.

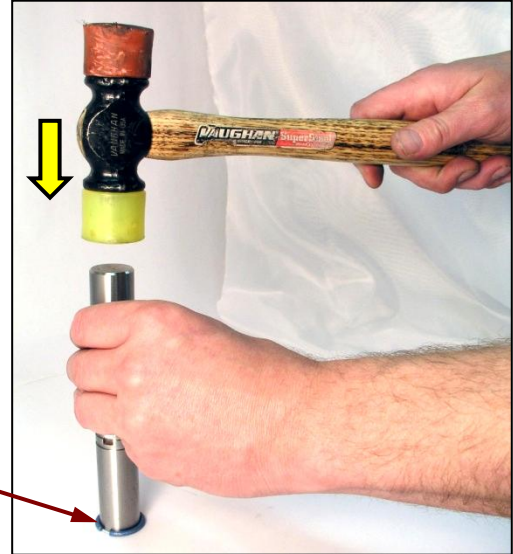

- 2 Strike the top end of the shaft with a rubber mallet to force the retaining ring onto the bottom end of the shaft.

First Retaining Ring

- 3 Push the retaining ring into the outer groove if a full (F) size gear will be installed or the inner groove if a reduced (R) size gear will be installed.

NOTE: The installation of a Model H12F or 312F gear will be shown.

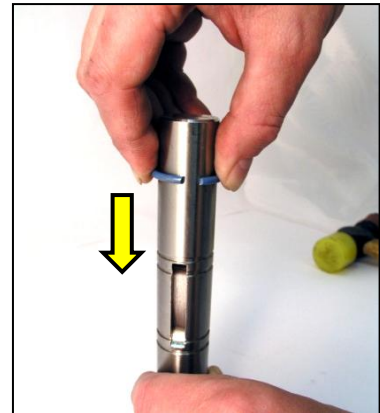

- 4 Install the key (24 or 23) on the shaft (1 or 20); then install the gear (6 or 22) so that it engages the key and contacts the retaining ring (4).

NOTE: 3-Series pumps use LY-type keys for Teflon gears and HY-type keys for all other gear materials. See Keys section on Page 41.

First Retaining Ring installed in Outer Groove for Model H12F or 312F Gear

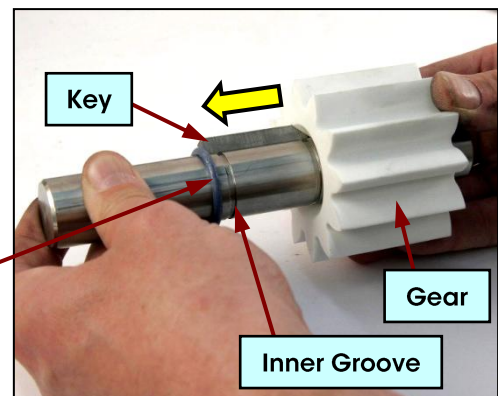

Appendix 5: Gear-Shaft Assembly (Continued)

- 5** While holding the gear in place, force the second retaining ring (4) onto the vacant end of the shaft by striking the opposite end of the shaft with a rubber mallet, as shown.

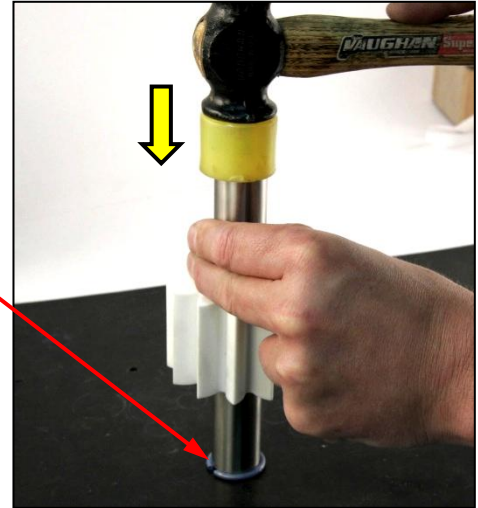

Second Retaining Ring

- 6** Slide the retaining ring into the vacant outer groove if a full (F) size gear was installed or the vacant inner groove if a reduced (R) size gear was installed. (This will lock the gear on the shaft.)

- 7** Pull the gear by hand along the axis of the shaft to make sure it is securely locked into position.



Idler Gear-Shaft Assembly

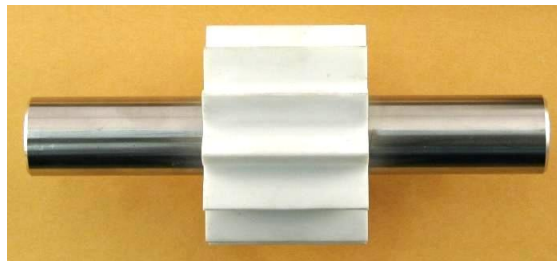

END OF PROCEDURE

Appendix 6: Reference Drawings

Sectional Drawing #1 – Pump with PACKING SEAL

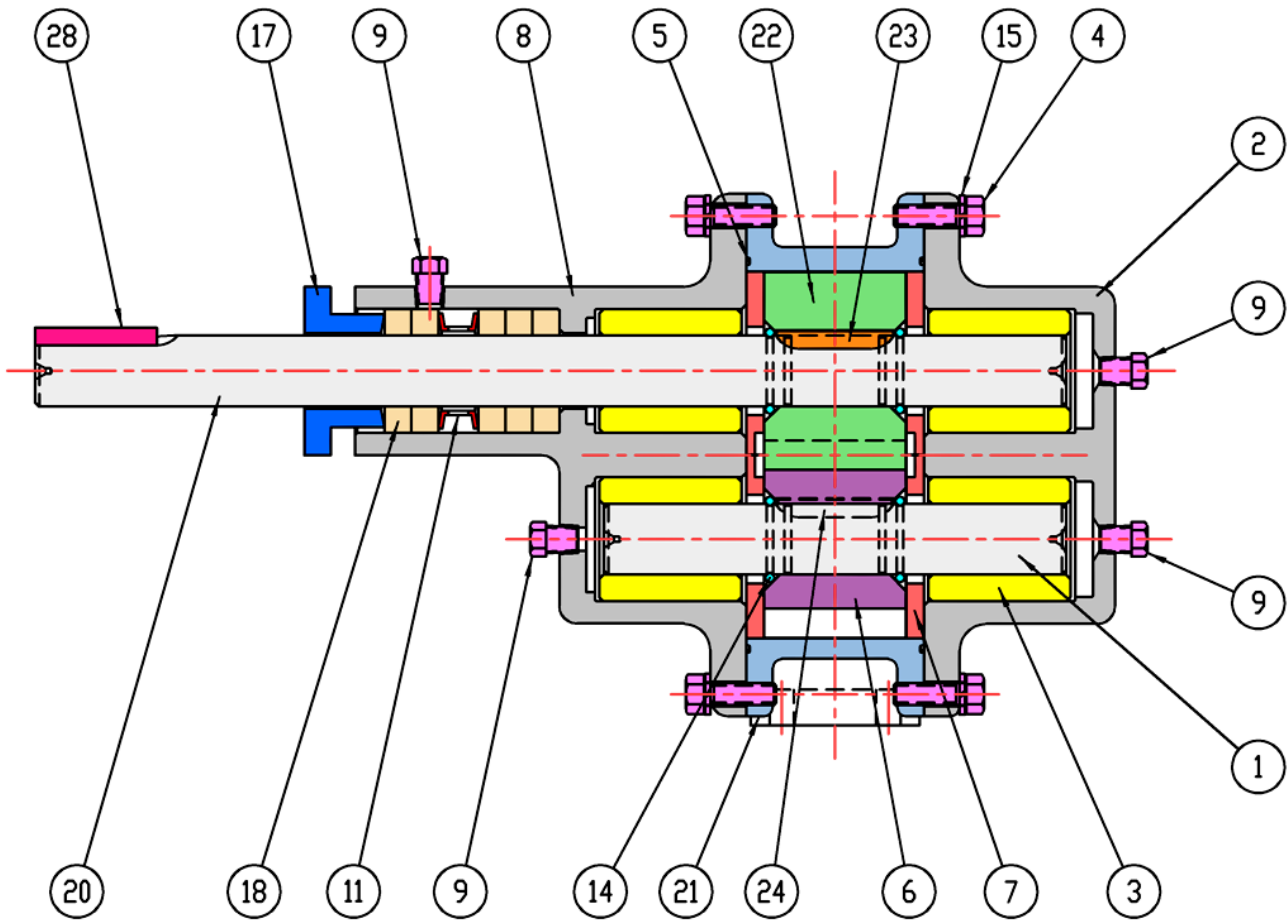

Ref. #	Description	Qty.	Ref. #	Description	Qty.
1	Idler Shaft	1	15	Lockwasher, Housing (5/16)	12
2	Rear Housing	1	16	Bolt, Gland (5/16-18 x 1 1/4 HHCS) (Not Shown)	2
3	Bearing	4	17	Gland Plate, Split	2
4	Bolt, Housing (5/16-18 x 1 HHCS)	12	18	Packing Ring	5
5	O-ring, Housing	2	19	N/A	-
6	Idler Gear	1*	20	Drive Shaft	1
7	Wear Plate	4	21	Center Housing	1
8	Front Housing	1	22	Drive Gear	1*
9	Plug, 1/8 NPT	5 †	23	Key, Drive Gear	1
10	N/A	-	24	Key, Idler Gear	1
11	Lantern Ring	1	25	Grease Fitting (Not Shown) ^Δ	1
12	Pin, Housing Alignment (Not Shown)	4	26	N/A	-
13	Pin, Bearing Lock (Not Shown)	4	27	N/A	-
14	Retaining Ring, Gear	4	28	Key, Mechanical Coupling	1

* Quantity is 2 for Model 314F pump (see Page 39).

† One side plug is not shown (see Page 48).

^Δ Grease fitting is located on side of front housing and is aligned with the lantern ring (see Page 48).

NOTE: For Liquiflo Part Numbers, refer to H-Series or 3-Series Consolidated Bill of Materials (BOM).

Appendix 6: Reference Drawings (Continued)

Sectional Drawing #2 - Pump with SINGLE INTERNAL MECHANICAL SEAL

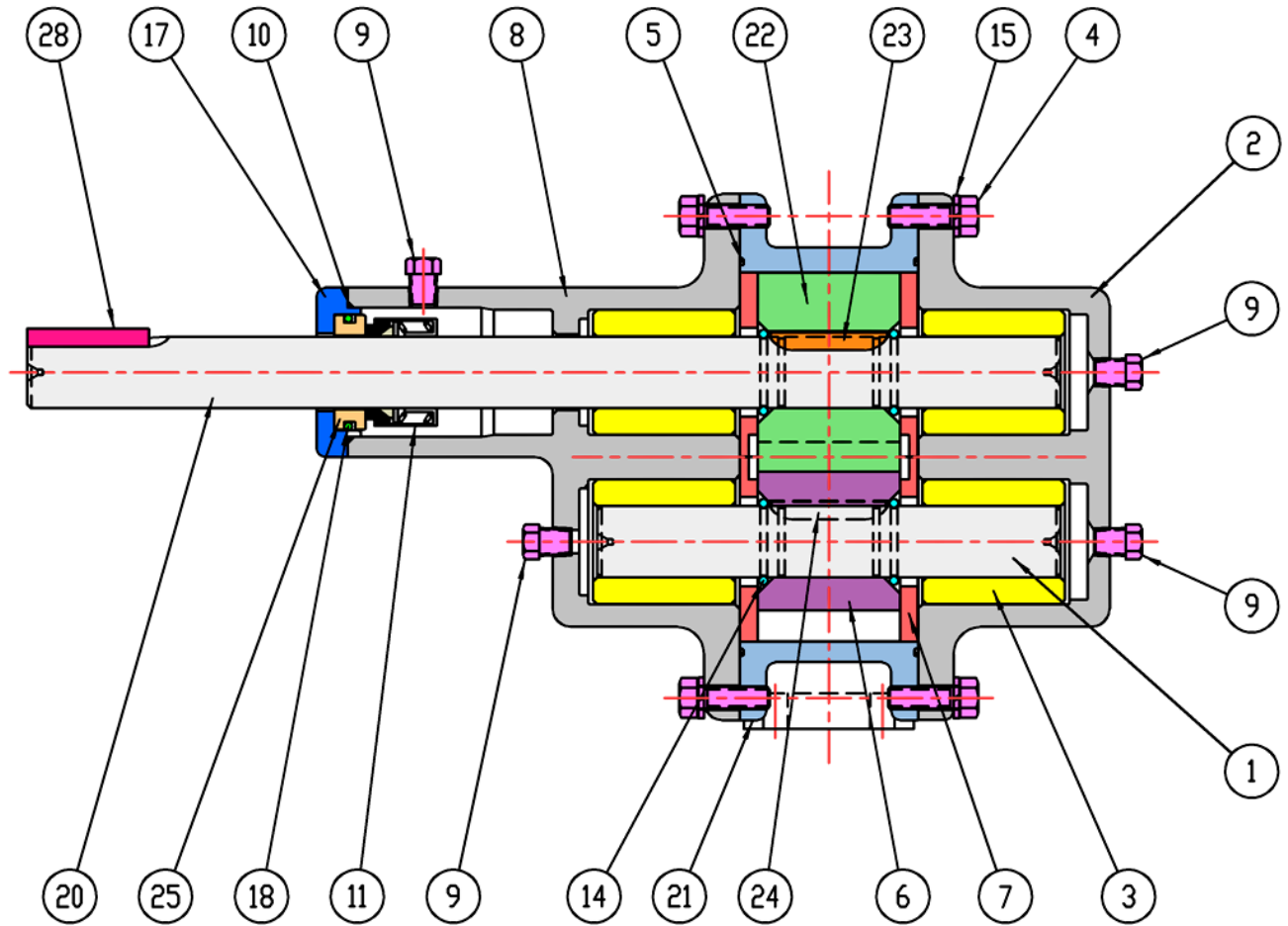

Ref. #	Description	Qty.	Ref. #	Description	Qty.
1	Idler Shaft	1	15	Lockwasher, Housing (5/16)	12
2	Rear Housing	1	16	Bolt, Gland (5/16-18 x 1 HHCS) (Not Shown)	2
3	Bearing	4	17	Gland Plate	1
4	Bolt, Housing (5/16-18 x 1 HHCS)	12	18	O-ring, Seal Seat, Outer	1
5	O-ring, Housing	2	19	Lockwasher, Gland (5/16) (Not Shown)	2
6	Idler Gear	1*	20	Drive Shaft	1
7	Wear Plate	4	21	Center Housing	1
8	Front Housing	1	22	Drive Gear	1*
9	Plug, 1/8 NPT	6 †	23	Key, Drive Gear	1
10	O-ring, Gland Plate	1	24	Key, Idler Gear	1
11	Mechanical Seal	1	25	Seal Seat, Outer	1
12	Pin, Housing Alignment (Not Shown)	4	26	N/A	-
13	Pin, Bearing Lock (Not Shown)	4	27	N/A	-
14	Retaining Ring, Gear	4	28	Key, Mechanical Coupling	1

* Quantity is 2 for Model 314F pump (see Page 39).

† Two side plugs are not shown (see Page 48).

NOTE: For Liquiflo Part Numbers, refer to H-Series or 3-Series Consolidated Bill of Materials (BOM).

Appendix 6: Reference Drawings (Continued)

Sectional Drawing #3 – Pump with EXTERNAL MECHANICAL SEAL

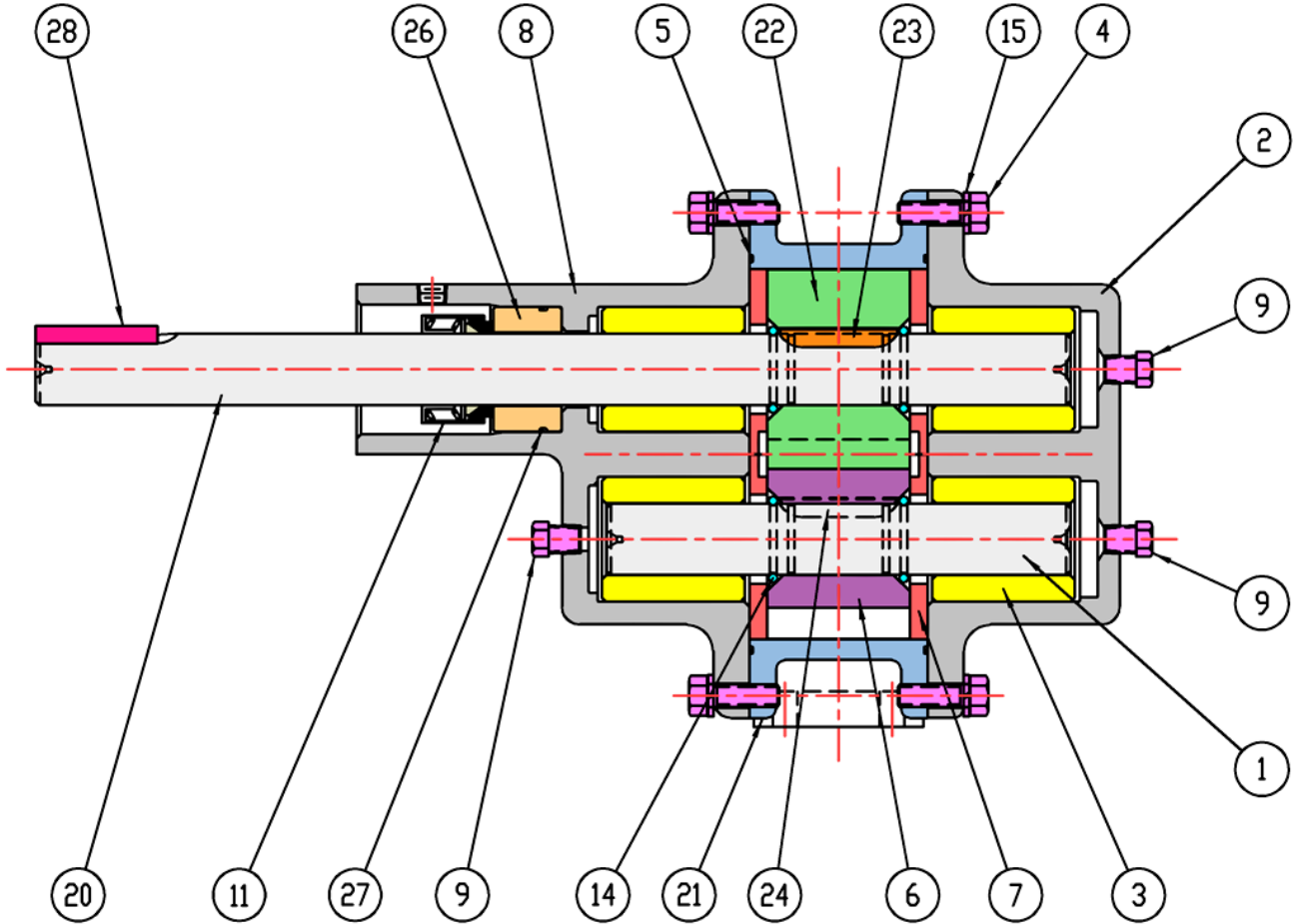

Ref. #	Description	Qty.	Ref. #	Description	Qty.
1	Idler Shaft	1	15	Lockwasher, Housing (5/16)	12
2	Rear Housing	1	16	N/A	-
3	Bearing	4	17	N/A	-
4	Bolt, Housing (5/16-18 x 1 HHCS)	12	18	N/A	-
5	O-ring, Housing	2	19	N/A	-
6	Idler Gear	1*	20	Drive Shaft	1
7	Wear Plate	4	21	Center Housing	1
8	Front Housing	1	22	Drive Gear	1*
9	Plug, 1/8 NPT	3	23	Key, Drive Gear	1
10	N/A	-	24	Key, Idler Gear	1
11	Mechanical Seal	1	25	N/A	-
12	Pin, Housing Alignment (Not Shown)	4	26	Seal Seat, Inner	1
13	Pin, Bearing Lock (Not Shown)	4	27	O-ring, Seal Seat, Inner	1
14	Retaining Ring, Gear	4	28	Key, Mechanical Coupling	1

* Quantity is 2 for Model 314F pump (see Page 39).

NOTE: For Liquiflo Part Numbers, refer to H-Series or 3-Series Consolidated Bill of Materials (BOM).

Appendix 6: Reference Drawings (Continued)

Sectional Drawing #4 - Pump with DOUBLE MECHANICAL SEAL

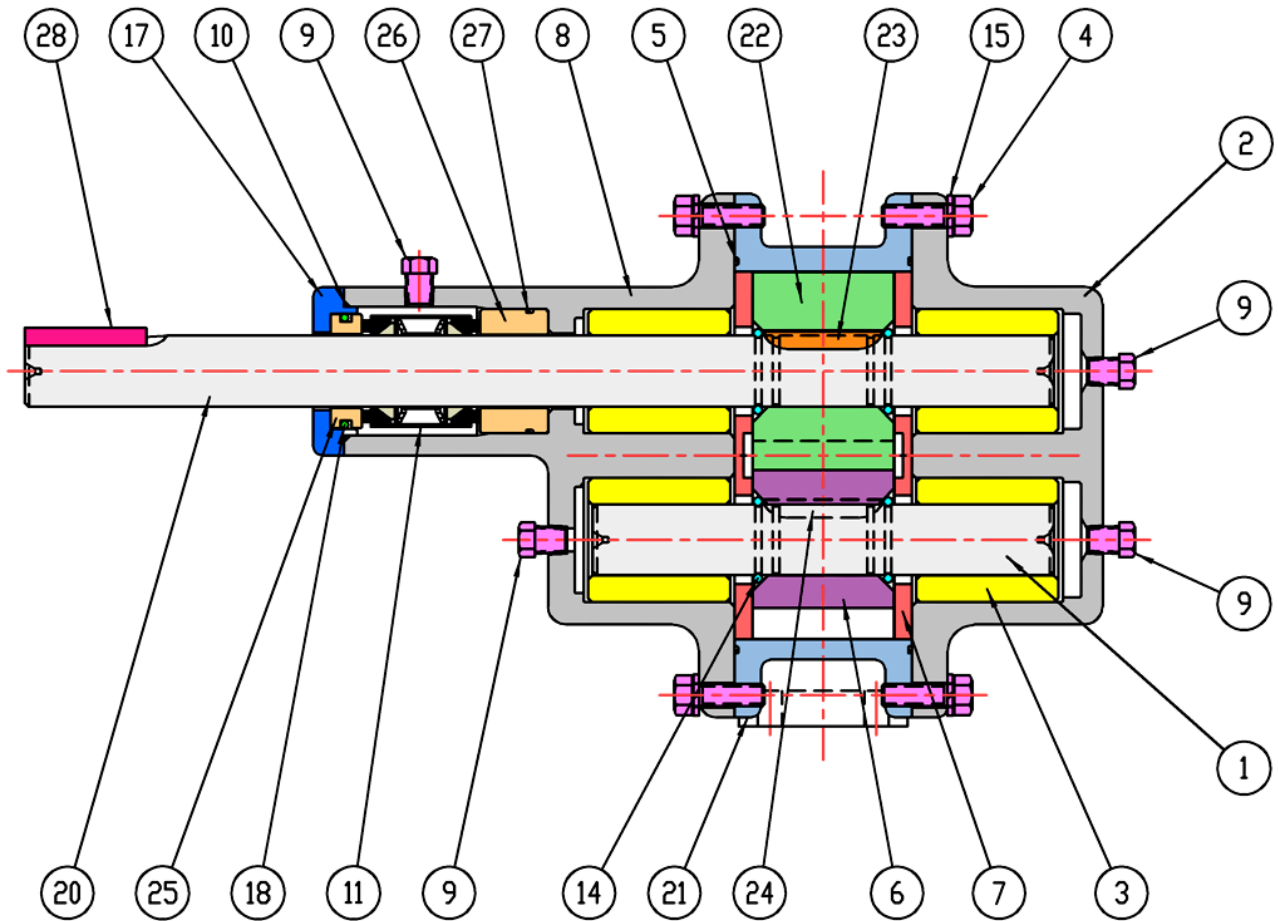

Ref. #	Description	Qty.	Ref. #	Description	Qty.
1	Idler Shaft	1	15	Lockwasher, Housing (5/16)	12
2	Rear Housing	1	16	Bolt, Gland (5/16-18 x 1 HHCS) (Not Shown)	2
3	Bearing	4	17	Gland Plate	1
4	Bolt, Housing (5/16-18 x 1 HHCS)	12	18	O-ring, Seal Seat, Outer	1
5	O-ring, Housing	2	19	Lockwasher, Gland (5/16) (Not Shown)	2
6	Idler Gear	1*	20	Drive Shaft	1
7	Wear Plate	4	21	Center Housing	1
8	Front Housing	1	22	Drive Gear	1*
9	Plug, 1/8 NPT	4	23	Key, Drive Gear	1
10	O-ring, Gland Plate	1	24	Key, Idler Gear	1
11	Mechanical Seal, Double	1	25	Seal Seat, Outer	1
12	Pin, Housing Alignment (Not Shown)	4	26	Seal Seat, Inner	1
13	Pin, Bearing Lock (Not Shown)	4	27	O-ring, Seal Seat, Inner	1
14	Retaining Ring, Gear	4	28	Key, Mechanical Coupling	1

* Quantity is 2 for Model 314F pump (see Page 39).

NOTE: For Liquiflo Part Numbers, refer to H-Series or 3-Series Consolidated Bill of Materials (BOM).

Appendix 6: Reference Drawings (Continued)

Pump Exploded View Drawing – Sealed, Long-Coupled

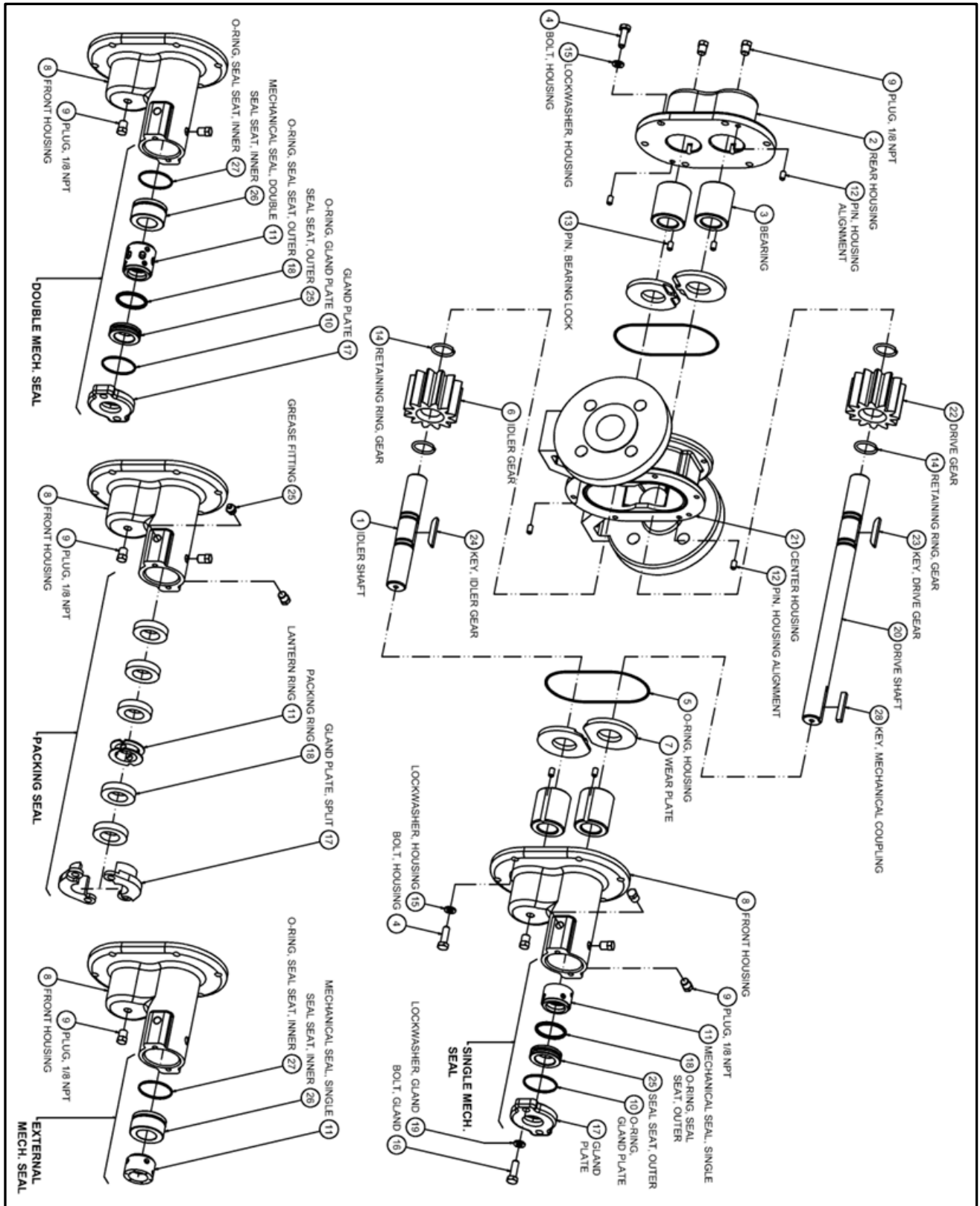

Appendix 6: Reference Drawings (Continued)

Pump Dimensional Drawings – Sealed, Long-Coupled

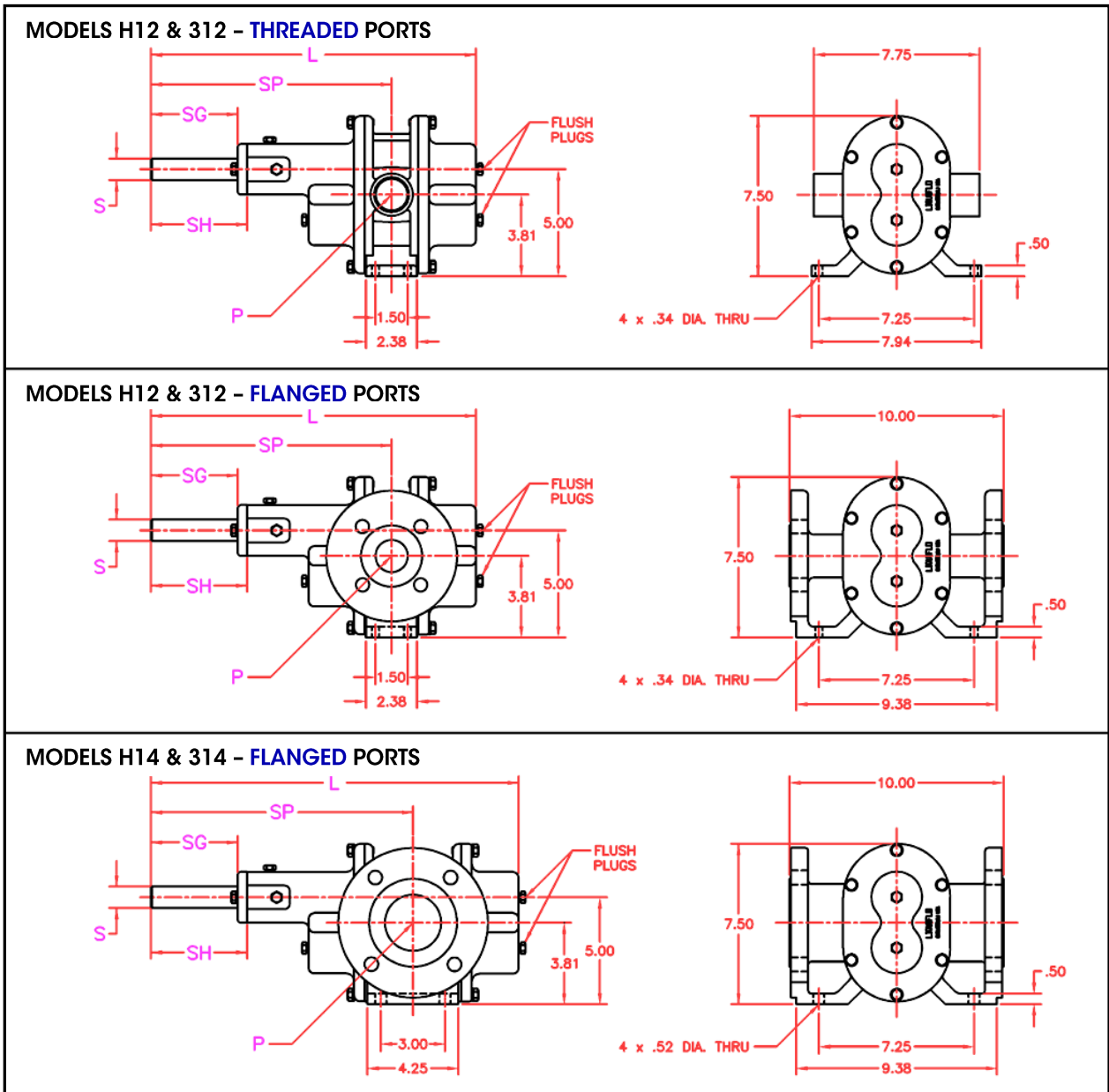

Units: inches

NOTE: Pump length (L) is measured from end of shaft to end of rear housing. Add 0.31 inches for Flush Plugs.

Dimensional Data – Sealed Pump

Pump Models	Port Size (P)			Shaft Dia. (S)	Shaft-to-Port CL (SP)	Pump Length (L)	SG		SH
	THREADED	FLANGED					Packing Seal *	Single & Double Seals	External Seal
	NPT or BSPT	ANSI 150# RF	DIN PN16						
Units:	in	in	mm	in	in	in	in	in	in
H12R & H12F	1-1/4	1-1/2	40	1-1/8	9.75	13.69	2.28	2.56	NA
H14F	NA	2-1/2	65	1-1/8	9.95	14.89	1.48	1.76	NA
312R & 312F	1-1/4	1-1/2	40	1	11.25	15.19	3.78	4.06	4.50
314F	NA	2-1/2	65	1	14.62	19.69	6.56	6.56	6.56

SG = End of Shaft-to-Gland

SH = End of Shaft-to-Housing

NA = Not Available

* Minimum dimension.

Appendix 7: Operation of Dynamic Seals

Liquiflo pumps can be configured with several types of dynamic seals. The choice of seal will depend mainly on the pumping application. To maximize the lifetime of the seal and to ensure that it operates properly, it must be correctly installed and applied, and in some cases, properly adjusted or supported. This section covers the basic operation of the seal arrangements used in Liquiflo Models H12-H14 and 312-314. (Refer to the Cross-Sectional Drawings in **Appendix 6**.)

A. Packing Seal

Although Packing is still used, it is not very common in the chemical processing industry because of its normal leak rate with low to moderate viscosity fluids. It is still considered to be an acceptable solution when pumping safe liquids or where the seal drainage can be captured. Flocculants, water and caustics are common examples of fluids which use this type of seal. Teflon is the standard packing material. Graphoil packing is used for high temperature applications over 350 °F up to 500 °F.

During operation, the shaft-packing interface must be lubricated to reduce frictional forces on the rotating drive shaft. Depending on the fluid, this can be accomplished in several ways: With low to moderate viscosity liquids, the gland screws are adjusted to provide a leak rate of about 8 to 10 drops per minute. With high viscosity liquids, grease can be administered into the seal chamber via the grease fitting. For crystallizing liquids, a flush fluid can be made to flow across the seal chamber, via the two 1/8" NPT ports. In all cases, the packing should be properly compressed by adjusting the glands screws. Under-compression will result in excessive leakage, and over-compression can cause excessive loading and heating of the drive shaft, which will lead to premature failure of the packing seal.

B. Single Internal Mechanical Seal

The Single Mechanical Seal arrangement is the dynamic seal standard and is by far the most commonly used when pumping any type of chemical where leakage needs to be minimized. Although widely used, this seal has some important limitations. The seal can tolerate only limited amounts of abrasive particles and because it is non-hermetic, it is not ideal for pumping fluids that can crystallize on contact with air. Crystals can build up around the edges of the seal and cause premature seal failure. Because of lubrication requirements, the maximum recommended fluid viscosity is 5,000 cP.

During operation, the rotating seal face seals against a stationary seal seat. To be effective, the working surfaces of the seal faces must be extremely flat and the pumped fluid must be present to lubricate the interface and remove the heat caused by friction. The sealing and frictional forces are a result of the mechanical spring pressure inside the seal body and the hydraulic pressure inside the seal chamber. If the pump is run dry for more than a few seconds, the frictional forces will cause rapid wear and damage the seal. Pumping very high viscosity fluids can also cause premature seal wear because of poor lubrication.

The most common seal combination is a Carbon seal face vs. a Silicon Carbide (SiC) seal seat. If the seal is properly applied, it can be used to pump many chemicals up to differential pressures of 150 PSI or higher. For fluids not compatible with Carbon, Teflon can be used for the seal face material. However, due to its weaker physical strength, the working pressure of a Teflon seal must be limited to about 50 PSI. For fluids containing very low levels of abrasives, a SiC vs. SiC seal combination can be used. For higher levels of abrasives, a double mechanical seal can be used (see page 51). (Note: When pumping abrasive fluids, it is beneficial to use a larger pump running at lower speeds. This will significantly lower the wear rate and increase the working life of the pump. Gear pumps, in general, have limitations on pumping fluids containing suspended solid particles. See **Section 3.3**, Page 11.)

Appendix 7: Operation of Dynamic Seals (Continued)

C. External Mechanical Seal

Although the External Mechanical Seal is located inside the pump's seal chamber (as shown on Page 46), its body is *external* relative to the liquid inside the pump. This arrangement has the following advantages: Because the metallic body of the seal is isolated from the pumpage, it does not have to be chemically compatible with the pumped liquid and replacement of the mechanical seal is simplified because the pump does not always have to be disassembled. Another important advantage of the external seal is that it can be applied when system pressures are below atmospheric (< 0 PSIG or vacuum). This is because the atmospheric pressure will assist the mechanical spring pressure inside the seal body in holding the seal faces together. The main disadvantage of the external seal is that the hydraulic pressure inside the seal chamber is working against the seal faces. This makes the external seal less effective than the single internal seal when operating above atmospheric pressure. In addition, the external seal also has the same limitations as the single internal seal when pumping viscous, abrasive or crystallizing fluids.

D. Double Mechanical Seal

The Double Mechanical Seal is a more complex sealing arrangement, but when properly supported, it overcomes the limitations of the other seal types discussed above. As shown below, the double mechanical seal requires a *barrier fluid lubrication system* to cool and flush the seal faces. The barrier fluid must be safe and compatible with the pumpage, have a net flow across the seal chamber via the 1/8" NPT ports and must be pressurized to at least 15 PSI above the pump discharge pressure. The double mechanical seal is preferred for pumping abrasive, crystallizing or extremely hazardous fluids because the seal faces are only exposed to the flush fluid and the pumpage is completely contained by the inboard seal. The double seal can also pump viscous fluids greater than 5,000 cP and can even run dry as long as the barrier fluid is present. Failure to support the double seal will cause rapid wear and ensuing failure of both the inboard and outboard seals. The main disadvantage of the double seal is the added complexity and cost of the barrier fluid lubrication system. An alternative to the sealed pump, with a properly supported double mechanical seal, is the sealless (magnetic-drive) pump. In addition to its simpler containment system, the mag-drive pump can prove to be a more reliable and cost-effective solution over time.

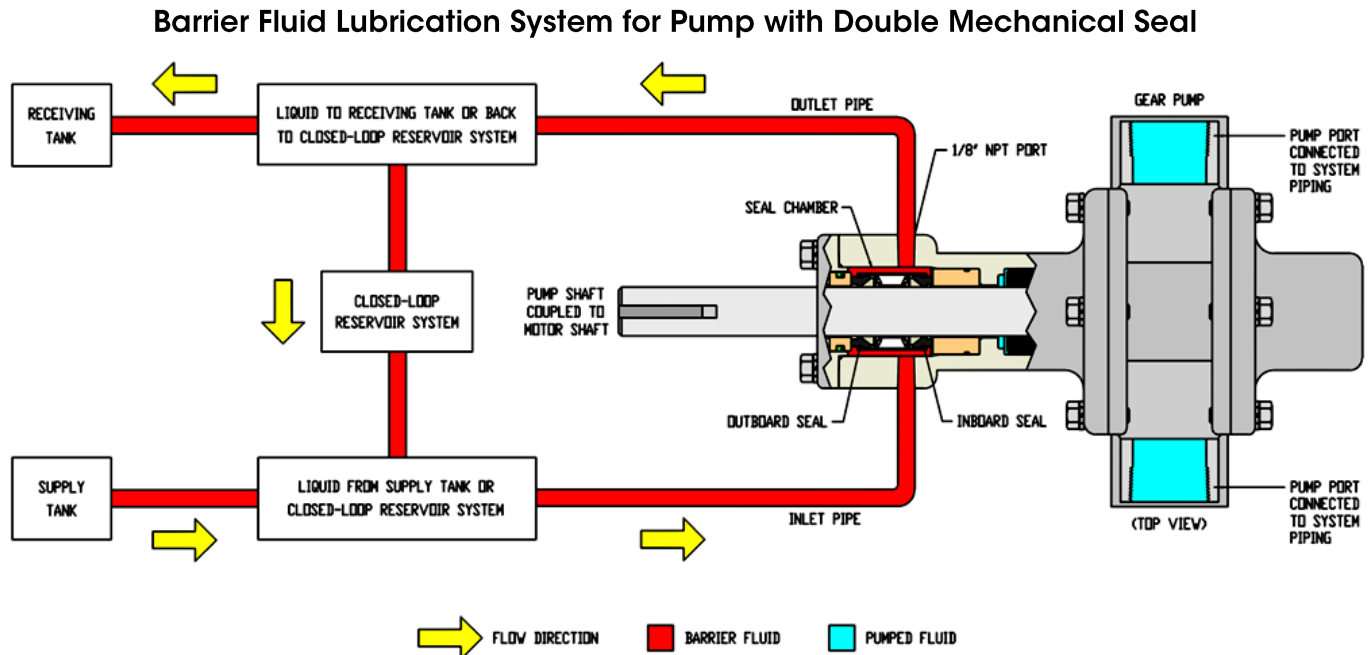

Appendix 8: Troubleshooting Guide

Troubleshooting Guide - Part 1

Problem	Possible Cause	Corrective Action
No discharge	Pump not primed	Verify suction pipe is submerged. Increase suction pressure. Open suction valve.
	Wrong direction of rotation	Reverse motor leads or reverse suction and discharge piping.
	Valves closed	Open all suction and discharge valves.
	Bypass valve open	Close bypass valve.
	Air leak in suction line	Tighten connections. Apply sealant to all threads. Verify suction pipe is submerged.
	Clogged strainer	Clean strainer.
	Pump worn or damaged	Rebuild pump.
Insufficient discharge	Suction pressure too low	Increase suction pressure. Verify suction piping is not too long. Fully open any suction valves.
	Bypass valve open	Close bypass valve.
	Partly clogged strainer	Clean strainer.
	Speed too low	Increase driver speed, if possible. Use larger size pump, if required.
	Pump worn or damaged	Rebuild pump.
Loss of suction after satisfactory operation	Pump not properly primed	Reprime pump.
	Air leaks in suction line	Tighten connections. Apply sealant to all threads. Inspect gaskets, if applicable. Verify suction pipe is submerged.
	Air or vapor pockets in suction line	Rearrange piping as necessary.
	Increase in fluid viscosity	Heat fluid to reduce viscosity. Reduce pump speed.
Excessive power consumption	Fluid viscosity higher than specified	Heat fluid to reduce viscosity. Reduce pump speed. Increase driver horsepower.
	Differential pressure greater than specified	Increase pipe diameter. Decrease pipe run.
	Gear clearances insufficient for fluid viscosity	Purchase gears trimmed for the correct viscosity.
	Plastic gear clearance insufficient for fluid temperature	Purchase plastic gear trimmed for the correct temperature.
	Rotating parts binding or severely worn	Disassemble pump and replace worn parts.

Appendix 8: Troubleshooting Guide (Continued)

Troubleshooting Guide - Part 2

Problem	Possible Cause	Corrective Action
Rapid pump wear	Abrasives in fluid	Install suction strainer. Limit solids concentration. Reduce pump speed or use larger pump running at lower speed.
	Corrosion wear	Use materials of construction that are acceptable for fluid being pumped.
	Extended dry running	Install power sensor to stop pump.
	Discharge pressure too high	Increase pipe diameter. Decrease pipe run.
	Housing stress from piping	Align piping with pump ports. Support piping independently of pump.
	Misalignment	Align pump and motor.
Excessive noise and vibration	Suction and/or discharge piping not anchored or properly supported	Anchor per Hydraulic Institute Standards.
	Base not rigid enough	Tighten hold-down bolts on pump and motor or adjust stilts. Inspect grout and regrout if necessary.
	Worn pump bearings	Replace bearings.
	Worn motor bearings	Replace bearings or motor.
	Pump cavitation	Increase NPSH available.
	Misalignment	Align pump and motor.
Excessive product leakage	Static seal failure caused by chemical incompatibility or thermal breakdown	Use O-rings or gaskets made of material compatible with fluid and temperature of the application.
	Static seal failure caused by improper installation	Install O-rings or gaskets without twisting or bending. Use star-pattern torque sequence on housing bolts during assembly. Allow Teflon O-rings to cold flow and seat during tightening. Torque bolts to specification.
	Dynamic seal worn or damaged	Disassemble and replace seal. Prime pump and avoid dry running.
	Pump port connections not properly sealed	Use Teflon tape or other suitable sealant. Use gaskets compatible with fluid and temperature of the application.
	Crevice corrosion of pump housing material	Only pump chemicals that are compatible with the pump housing material. Decrease temperature to reduce corrosion rate to acceptable value. Flush idle pumps that are used to pump corrosive chemicals. Eliminate contaminants in the fluid that can accelerate corrosion wear.

