

# MILROYAL<sup>®</sup> SERIES

Metering Pumps

PD 3621

## MILROYAL D Pumps

The MILROYAL D is a robust industrial duty metering pump for use in critical processes in oil and gas, chemical and hydrocarbon processes, water and waste treatment, and in most industries where chemical injection is required.

The MILROYAL design is modular thus allowing it to accept a variety of liquid ends and other options that perfectly tune it to process requirements. Multiplex configurations provide even greater application flexibility.

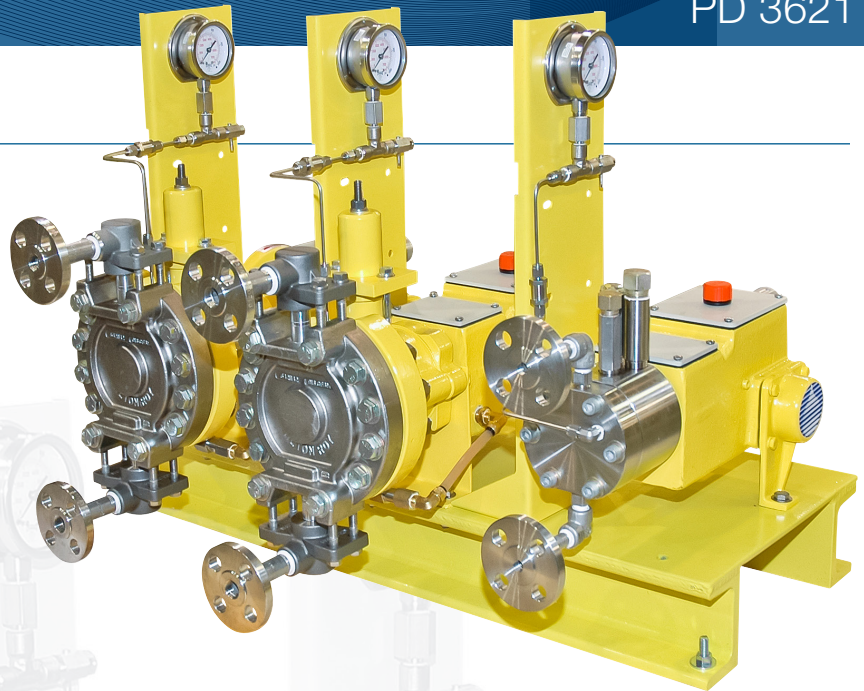

MILROYAL D Triplex with HPD Liquid End

## General Specifications

### Drive

Polar crank design - all moving parts submerged in oil.

### Liquid Ends Available

High Performance Diaphragm (HPD) or Packed Plunger

### Multiplexing

Up to 6 pumps driven by one motor. Limited to a maximum of 25 HP.  
Consult applications engineering concerning capabilities for a specific application.

### Maximum Performance Ratings (per head)

53 gph @ 70 psig (200 l/h @ 5 bar) to  
0.5 gph @ 3,000 psig (1.9 l/h @ 207 bar)

### Capacity Control

Manual micrometer standard; Electronic stroke length control or variable speed optional

### Accuracy

±1.0% over 10:1 turndown ratio

### Weight with Motor (simplex; approximate)

HPD = 195 lbs. (88 kg); Packed plunger = 95 lbs. (43 kg)

## TYPICAL PERFORMANCE (See note 1)

### Packed Plunger

Plunger Diameter	Gear Ratio Code	Maximum Capacity		1/4 HP (0.25 kW)		1/3 HP (0.25 kW)	
				Maximum Discharge Pressure			
		ml/H	GPH	PSIG	BAR	PSIG	BAR
1/8 in (3 mm)	60	305	0.081	300	21	-	-
	30	615	0.162	300	21	-	-
	15	1,200	0.316	300	21	-	-
	10	1,800	0.475	300	21	-	-
1/8 HP (3 mm)	60	125	0.033	3000	207	-	-
	30	245	0.065	3000	207	-	-
	15	480	0.126	3000	207	-	-
1/4 in (6 mm)	60	1,230	0.325	300	21	-	-
	30	2,460	0.650	300	21	-	-
	15	4,800	1.270	300	21	-	-
	10	7,150	1.880	300	21	-	-
1/4 HP (6 mm)	60	495	0.131	3000	207	-	-
	30	985	0.260	3000	207	-	-
	15	1,920	0.508	3000	207	-	-
7/16 in (11 mm)	60	3,785	1.000	1000	69	-	-
	30	7,570	2.000	1000	69	-	-
	15	15,520	4.100	1000	69	-	-
	10	23,090	6.100	1000	69	-	-
5/8 in (16 mm)	60	7,950	2.100	650	45	-	-
	30	15,845	4.200	650	45	-	-
	15	31,795	8.400	-	-	650	45
	10	47,310	12.500	-	-	650	45

## TYPICAL PERFORMANCE

### High Performance Diaphragm

Plunger Diameter	Gear Ratio Code	Maximum Capacity		1/3 HP (0.25 kW)		1/2 HP (0.37 kW)	
				Maximum Discharge Pressure			
		L/H	GPH	PSIG	BAR	PSIG	BAR
1 in (25 mm)	60	19.7	5.2	220	15	-	-
	30	39.4	10.4	220	15	-	-
	15	76.5	20.2	190	13	220	15
1¼ in (32 mm)	60	33.3	8.8	145	10	-	-
	30	66.2	17.5	130	9	145	10
	15	129	34.1	100	7	145	10
1½ in (11 mm)	60	51.5	13.6	70	5	-	-
	30	103	27.2	70	5	-	-
	15	200	53.0	-	-	70	5

#### NOTES:

1. Typical performance based on 1725 RPM, 60 hz motor. Derate flow rates for all other RPM speeds.
2. Plastic liquid ends are limited to 150 PSIG (10 Bar) @68°F (20°C) and are linearly derated to 65 PSIG (4 Bar) @ 140°F (60°C).

## PACKED PLUNGER MODEL CODE

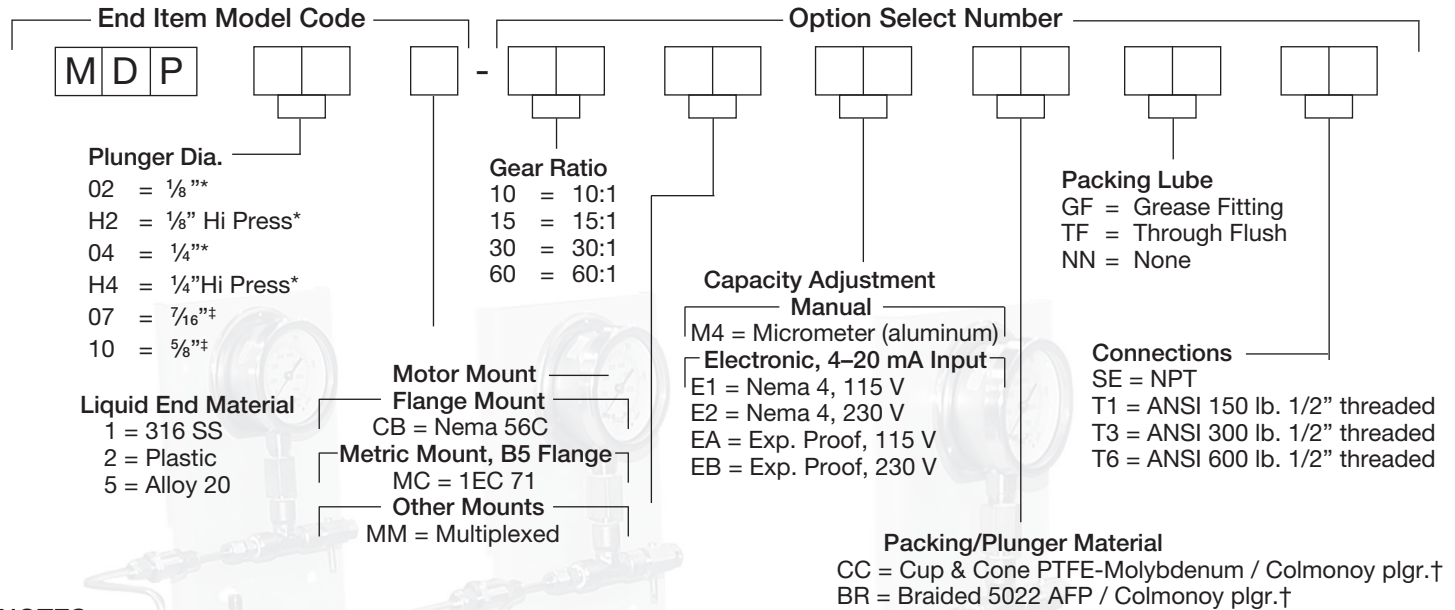

### NOTES:

- \* 1/4" & 1/8" plunger diameters are only available in Alloy 20 and Plastic liquid end materials and with packing lube NN.
- † Packing/plunger material code CC is only available with 1/8" and 1/4" plungers. Packing/plunger material code BR is only available with 7/16" & 5/8" plungers.
- ‡ 7/16" & 5/8" plunger diameters are only available in 316 SS and Alloy 20 liquid end materials. Ceramic balls with tungsten carbide seats are available on 7/16" & 5/8" plunger diameter pumps with 316 SS liquid end (for slurry service).

## HIGH PERFORMANCE DIAPHRAGM (HPD) MODEL CODE

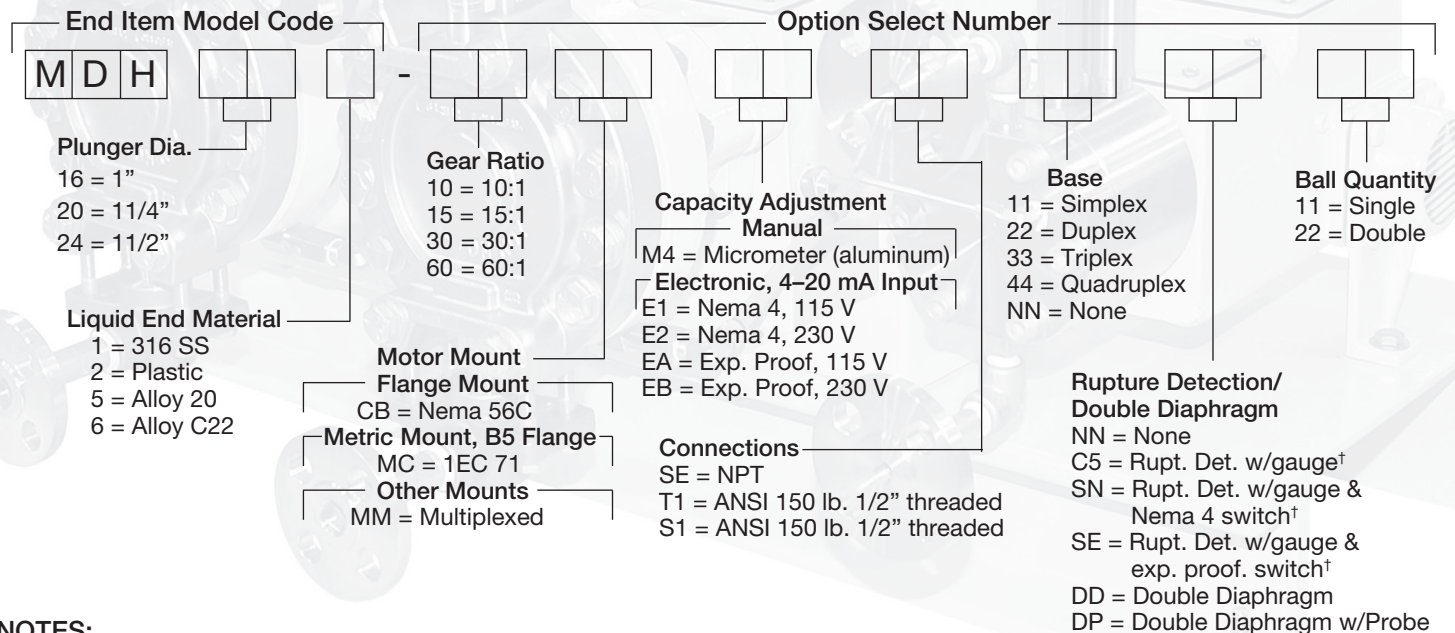

### NOTES:

- \* Plastic liquid ends are available with double ball checks only.
- † Rupture detection options C5, SN, and SE are only available on metallic liquid ends.
- ‡ Ceramic balls with tungsten carbide seats are available on 316 SS liquid ends (for slurry service).

## MATERIALS OF CONSTRUCTION

### Packed Plunger Liquid End

Materials of Construction	Liquid End	Ball Check	Ball Seat	Plunger	Cartridge Body	Packing	Gland Cap
Plastic	PVC	Sapphire	PVC	Ceramic	PVC	PTFE	PVC
Alloy 20	Alloy 20	Alloy 20 <sup>‡</sup>	Alloy 20	Colmonoy	Alloy 20	PTFE	Alloy 20
316 SS	316 SS	316 SS	316 SS	Colmonoy	316 SS	PTFE	316 SS

**NOTES:**

<sup>‡</sup> Ball checks in high pressure liquid end are sapphire.

### High Performance Diaphragm (HPD)

Materials of Construction	Diaphragm	Diaphragm Head	Port Connection	Ball Seat	Ball Check	Ball Guide
316 SS	PTFE/Elastomer	316 SS CF-8M*	316 SS CF-8M*	316 SS	316 SS	316 SS CF-8M*
Alloy 20	PTFE/Elastomer	20CB-3 CN-7M <sup>†</sup>	20Cb-D3 CN-7M <sup>†</sup>	20CB-3	20CB-3	20CB-3 CN-7M <sup>†</sup>
Plastic	PTFE/Elastomer	PVC	PVC	PVC	Ceramic	PVC
Alloy C22	PTFE/Elastomer	Alloy C22 CX2MW <sup>‡</sup>	Alloy C22 CX2MW <sup>‡</sup>	Alloy C22	Alloy C276	Alloy C22 CX2MW <sup>‡</sup>

**NOTES:**

\* CF-8M is the cast equivalent to wrought 316 SS.

<sup>†</sup> CN-7M is the cast equivalent to wrought 20CB-3.

<sup>‡</sup> CX2MW is the cast equivalent to wrought Alloy C22.

## DRIVE DIMENSIONS

### Side View

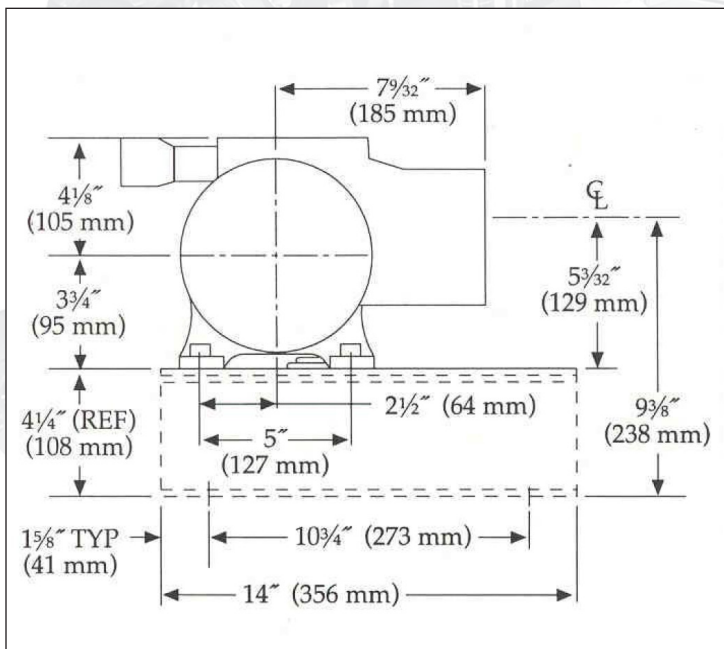

### Top View

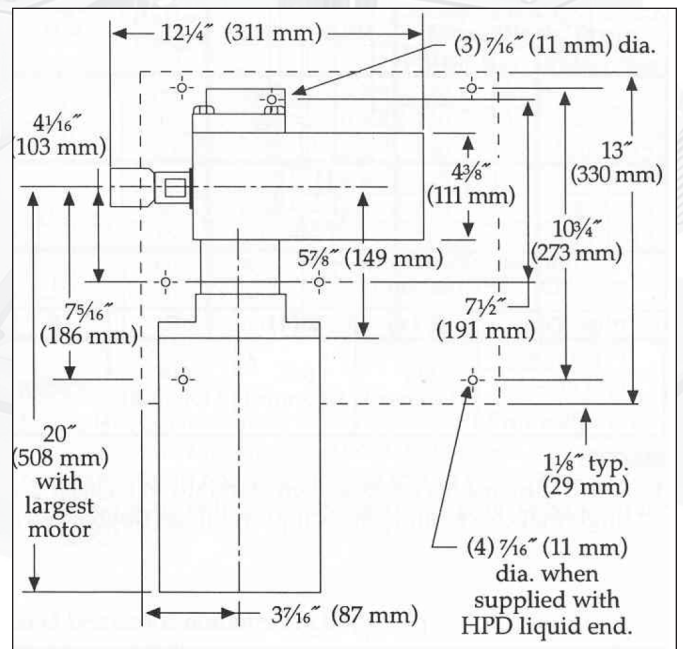

**NOTES:**

Base (shown as dotted lines) supplied only with HPD liquid end.

## PACKED PLUNGER LIQUID END DIMENSIONS

### 1/8 in & 1/4 in Diameter Plunger

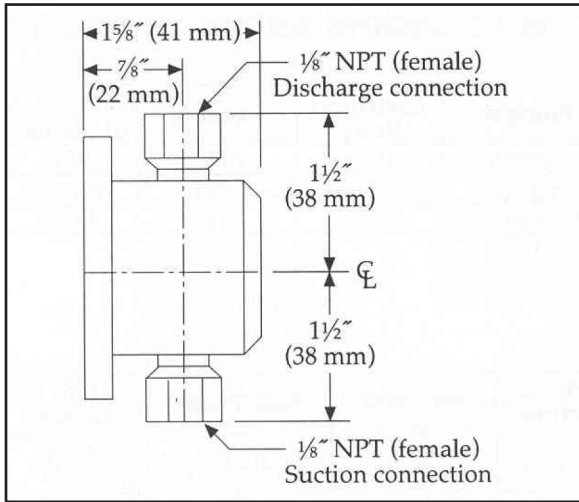

### 7/16 in & 5/8 in Diameter Plunger

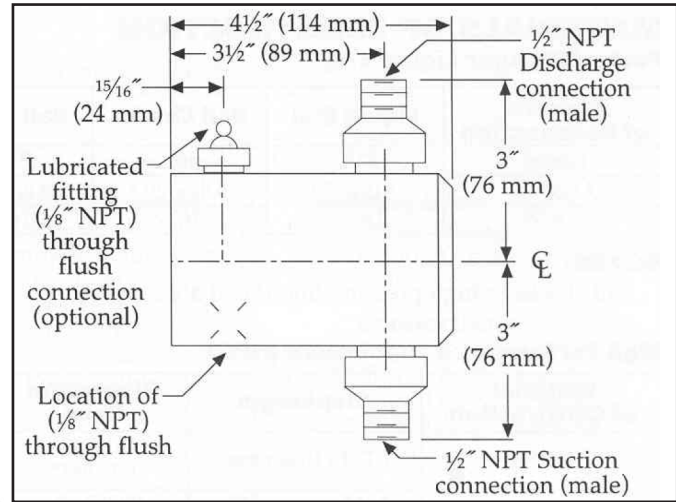

## HIGH PERFORMANCE DIAPHRAGM (HPD) LIQUID END DIMENSIONS

### 1/8 in & 1/4 in Diameter Plunger

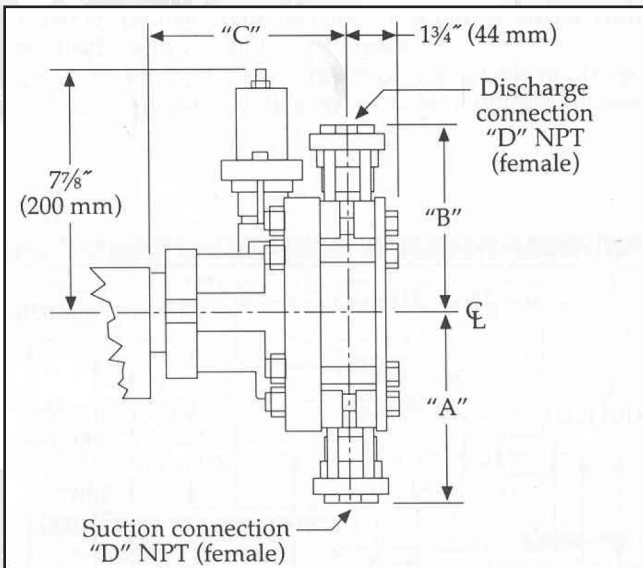

Plunger Diameter	A (1)	B (1)	C
1 in (25 mm)			
1 1/4 in (32 mm)	6 1/2 in (165 mm)	6 1/2 in (165 mm)	6 1/8 in (156 mm)
1 1/2 in (38 mm)			

### 7/16 in & 5/8 in Diameter Plunger

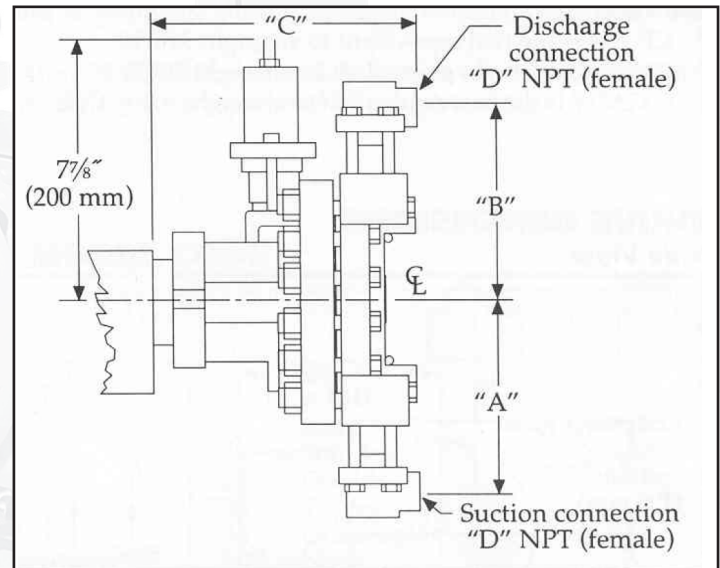

Plunger Diameter	A (1)	B (1)	C	D
1 in (25 mm)	4 13/16 in (122 mm)	4 13/16 in (122 mm)	7 7/8 in (200 mm)	1/2 in
1 1/4 in (32 mm)	5 7/32 in (133 mm)	5 7/32 in (133 mm)	7 5/8 in (194 mm)	
1 1/2 in (38 mm)				1/2 in

### NOTES:

1. A & B dimensions are based on standard ball check configuration and single diaphragm, where metallic liquid end has single ball checks and plastic liquid end has double ball checks. Consult factory for dimensions on optional configurations.