



an Accudyne Industries brand



Proteus™ Series

Electronic Metering Pump

Installation & Operation Manual (Enhanced Control)

Manual No.: 54189

Revision : 01

Rev. Date: 08/2016

Note: This manual is a supplement to 54038



an Accudyne Industries brand

Table of Contents

| | | |
|------------|---|-----------|
| 1.0 | Precautions | 1 |
| 2.0 | Introduction | 4 |
| 3.0 | Icons..... | 4 |
| 4.0 | Enhanced Control Operation..... | 6 |
| 4.1 | Analog Mode..... | 6 |
| 4.2 | Pulse Mode | 7 |
| 4.3 | Batch Mode | 9 |
| 4.4 | Cycle Timer | 10 |
| 4.5 | Timed Event Mode..... | 12 |
| 4.6 | Enhanced Control Inputs and Outputs | 13 |
| 4.6.1 | <i>Inputs</i> | <i>14</i> |
| 4.6.1.1 | Remote Internal/External Mode..... | 14 |
| 4.6.1.2 | Analog Tank Level Input..... | 15 |
| 4.6.1.3 | Configuring Enhanced Control Inputs..... | 15 |
| 4.6.2 | <i>Outputs</i> | <i>16</i> |
| 4.6.2.1 | Stroke Pulse | 17 |
| 4.6.2.2 | Pump Running..... | 17 |
| 4.6.2.3 | Pump Standby | 17 |
| 4.6.2.4 | Alarm Out | 17 |
| 4.6.2.5 | Internal/External Mode | 17 |
| 4.6.2.6 | User Alarm Out..... | 18 |
| 4.6.2.7 | Pump Stopped..... | 19 |
| 4.6.2.8 | Timed Event | 19 |
| 4.6.2.9 | Flow..... | 19 |
| 4.6.2.10 | Mirror Input AI1..... | 19 |
| 4.6.2.11 | Configuring Enhanced Control Outputs..... | 19 |
| 5.0 | Cable Wiring..... | 20 |
| 6.0 | Troubleshooting | 23 |

Table of Figures

- Figure 1: Analog Mode Home Screen 6
- Figure 2: Analog Adjust 6
- Figure 3: Pulse Mode Home Screen 8
- Figure 4: Pulse Adjust 8
- Figure 5: Batch Mode Home Screen 9
- Figure 6: Batch Adjust 10
- Figure 7: Cycle Timer Home Screen 11
- Figure 8: Cycle Timer Adjust 11
- Figure 9: Timed Event Home Screen 12
- Figure 10: Timed Event Adjust 13
- Figure 11: Int/Ext Select 15
- Figure 12: Configure Input 16
- Figure 13: Alarm Set 18
- Figure 14: Configure Output 19
- Figure 15: Cable Wiring Diagram 20
- Figure 16: Input Diagram for Digital Inputs DI1 - DI4 21
- Figure 17: Output Diagram for Digital Outputs DO1 – DO2 21
- Figure 18: Input Diagram for Analog 0-20mA Inputs AI1 - AI2 22
- Figure 19: Output Diagram for Analog 4-20mA Output AO1 22

1.0 Precautions

The following precautions should be taken when working with Milton Roy metering pumps. Please read this section carefully prior to installation.

Protective Clothing



ALWAYS wear protective clothing, face shield, safety glasses and gloves when working on or near your metering pump. Additional precautions should be taken depending on the solution being pumped. Refer to Safety Data Sheets (SDS) precautions from your solution supplier.

Water Pre-Prime



All Milton Roy pumps are pre-primed with water when shipped from the factory. If your solution is not compatible with water, disassemble the Pump Head Assembly. Thoroughly dry the pump head, valves, O-rings, balls and diaphragm. Reassemble head assembly tightening screws in a crisscross pattern. Refill the pump head with the solution to be pumped before priming the pump. (This will aid in priming.)

Liquid Compatibility



CAUTION: The evaluation performed by ETL was tested with water only. The pumps are certified to NSF 61 with: sodium hypochlorite (12.5%), sulfuric acid (98.5%), sodium hydroxide (50%), and hydrochloric acid (30%). Determine if the materials of construction included in the liquid handling portion of your pump are adequate for the solution (chemical) to be pumped. Always refer to the solution supplier and the Milton Roy Chemical Resistance Chart for compatibility of your specific Milton Roy metering pump. Contact your local Milton Roy distributor for further information.

Tubing Connections



Inlet and outlet tubing or pipe sizes must not be reduced. Outlet tubing size must not be increased. Make certain that all tubing is SECURELY ATTACHED to fittings prior to start-up (see section 3.3 Tubing Connections). ALWAYS use Milton Roy supplied tubing with your pump, as the tubing is specifically designed for use with the pump fittings. It is recommended that all tubing be shielded and secure to prevent possible injury in case of rupture or accidental damage. If tubing is exposed to sunlight, black UV resistant tubing should be installed. Check tubing frequently for cracks and replace as necessary.

Fittings and Machine Threads



All fittings should be hand-tightened. An additional 1/8 - 1/4 turn after the fitting is snug may be necessary to provide a leak-proof seal. Excessive overtightening or use of a pipe wrench can cause damage to the fittings, seals, or pump head.

Most Milton Roy pumps have straight screw machine threads on the head and fittings and are sealed by the O-rings. DO NOT use Teflon® tape or pipe dope to seal these threads. Teflon® Tape may only be used on NPT threads.

Plumbing



Always adhere to your local plumbing codes and requirements. Be sure installation does not constitute a cross connection. Check local plumbing codes for guidelines. Milton Roy is not responsible for improper installations.

PRECAUTIONS

Back Pressure/Anti-Syphon Valve



If you are pumping downhill or into low or no system pressure, a back pressure /anti-syphon device should be installed to prevent over pumping or syphoning. Contact your Milton Roy distributor for further information.

Electrical Connections



WARNING: To reduce the risk of electrical shock, the metering pump must be plugged into a properly grounded grounding-type receptacle with ratings conforming to the data on the pump control panel. The pump must be connected to a good ground. **Do not use adapters!** All wiring must conform to local electrical codes. If the supply cord is damaged, it must be replaced by the manufacturer, stocking distributor, or authorized repair center in order to avoid a hazard.

Fuse (all models) and Battery



CAUTION: Battery may explode if mistreated. Do not recharge, disassemble or dispose of in fire. The battery and fuse are internal, factory serviceable parts, and must be replaced by the factory or a qualified distributor with parts of the same type and rating.

Flooding



WARNING: Install this pump in a location where flooding cannot occur.

Ground Fault Circuit Interrupter



WARNING: To reduce the risk of electric shock, install only on a circuit protected by a Ground Fault Circuit Interrupter (GFCI).

Line Depressurization



To reduce the risk of chemical splash during disassembly or maintenance, all installations should be equipped with line depressurization capability.

Over Pressure Protection



To ensure safe operation of the pump it is recommended that some type of safety / pressure-relief valve be installed to protect the piping and other system components from failing due to excessive pressure.

Chemical Concentration



There is a potential for elevated chemical concentration during periods of no flow, for example, during backwash in the system. Steps, such as turning the pump off, should be taken during operation or installation to prevent this.

See your distributor about other external control options to help mitigate this risk.

Retightening Components



Plastic materials will typically exhibit creep characteristics when under pressure over a period of time and to insure a proper fit it may be necessary to retighten the head bolts periodically. To insure proper operation, we recommend tightening the bolts to 25 inch-pounds after the first week of operation and on a monthly basis thereafter.

PRECAUTIONS

Flow Display



The accuracy of the flow value as shown on the pump display is highly dependent on the specific application. Calibration is necessary in order to display an accurate measure of the flow.

Spills



CAUTION: Spills of Dangerous chemicals should be cleaned up immediately.

2.0 Introduction

Milton Roy's metering pumps deliver the highest level of repetitive accuracy and reliability with the capability to pump a wide range of chemicals. Our comprehensive selection of pumps means you get the right pump for the right application. Every one of our pumps is engineered to exceed expectations and is backed by a global network of highly trained field engineers and aftersales support.









This manual serves as a supplement to the Proteus™ Series Electronic Metering Pump Installation & Operation Manual, part number 54038. It covers information specific to the use, configuration and wiring of the additional modes of operation available in the enhanced control model pumps.

Please review this manual carefully. Pay particular attention to warnings and precautions. Always follow good safety procedures, including the use of proper clothing, eye and face protection.

3.0 Icons

Table 1 explains the function of display screen icons not covered in the 54038 manual.

Table 1: Enhanced Pump Icons

| | |
|---|-----------------------|
|  | Mode select |
|  | Manual mode |
|  | Analog mode |
|  | Batch mode |
|  | Pulse mode |
|  | Cycle timer mode |
|  | Timed event mode |
|  | Dosing is in progress |



Analogue pacing signal (loss of signal alarm)



Analogue pacing signal (signal over range)



Pulse input not synched



Max pump volume exceeded (in pulse mode)



Max flow exceed in batch mode

4.0 Enhanced Control Operation

This manual covers features supported in the enhanced control model Proteus™ Series pumps. Enhanced control features are driven by a variety of external inputs and outputs. Please see section 5.0 Cable Wiring for information on connections, signal types, and requirements.

4.1 Analog Mode

Analog mode allows control of the pump using an external 0 - 20 mA signal. The analog mode home screen is shown in Figure 1.

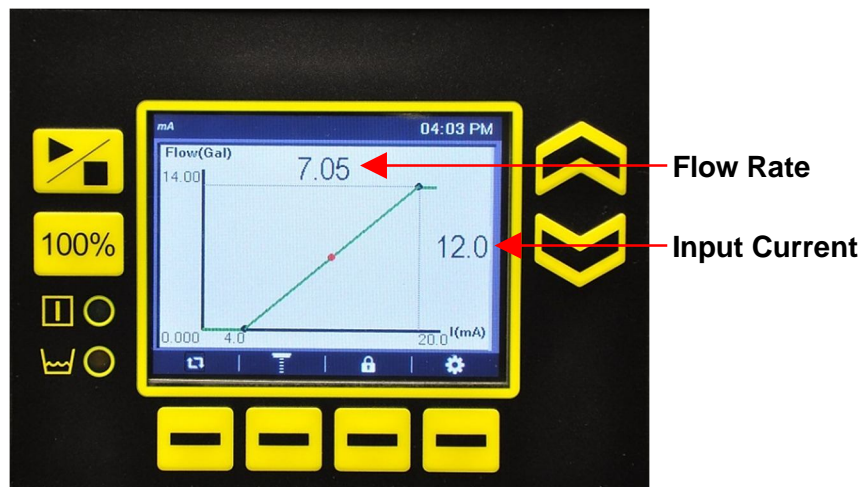

Figure 1: Analog Mode Home Screen

To configure the analog mode input parameters, press the **Up** or **Down** buttons to access the analog adjust screen (Figure 2).

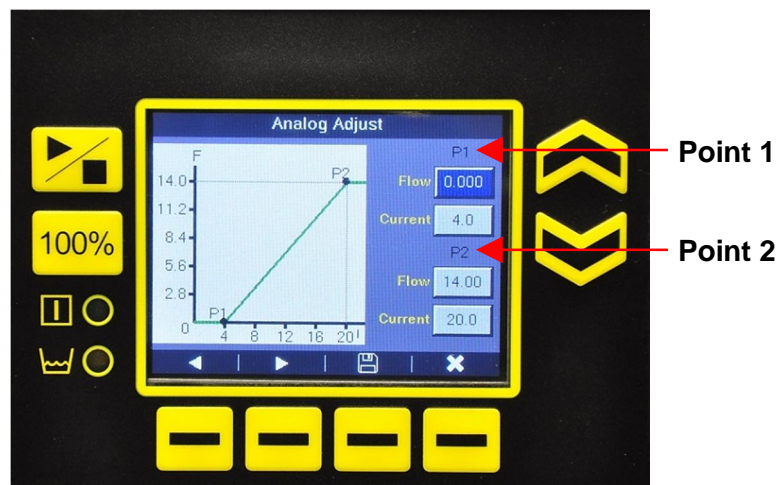











Figure 2: Analog Adjust

Press **Left**  or **Right**  to navigate to the parameter entry boxes. Enter the desired flow rates and currents at points P1 and P2. The range of allowable values for flow rate are from zero to the maximum capacity of the pump. Input signal current can range from 0.0 to 20.0 mA. Press **Save**  to retain the entered values and **Exit**  to return to the analog mode home screen. Press **Exit**  without pressing **Save**  to exit without modifying the parameters.

The linear relationship between signal current and flow can be increasing or decreasing. If the input signal is outside the operating range defined by the values entered by the user, the pump output will plateau at the defined flow limits. If the current exceeds 22 mA the **Signal Over Range**  icon will appear in the notification bar.

Any input current value of 0.5 mA or less will cause the pump to stop pumping and the **Loss of Signal**  icon will appear in the notification bar. The pump status indicator will remain green, showing the pump is still in “run” mode. When the input current rises above 0.5 mA again, the pump will resume pumping and the **Loss of Signal**  icon will be cleared from the notification bar.

Press the **Start / Stop** button to make the pump dose at the calculated flow rate. Starting and stopping can be done manually by pushing the **Start / Stop** button or remotely using the **Remote Start / Stop** function.

4.2 Pulse Mode

In pulse mode, the pump delivers a programmable volume of fluid, for a programmable number of incoming pulses from an external device (typically a flow meter). The result is a flow output that varies as the frequency of the incoming pulses varies, allowing the pump to track the external input.

From the pulse mode home screen (Figure 3) press the **Up** or **Down** buttons to get to the pulse adjust screen (Figure 4).



Figure 3: Pulse Mode Home Screen

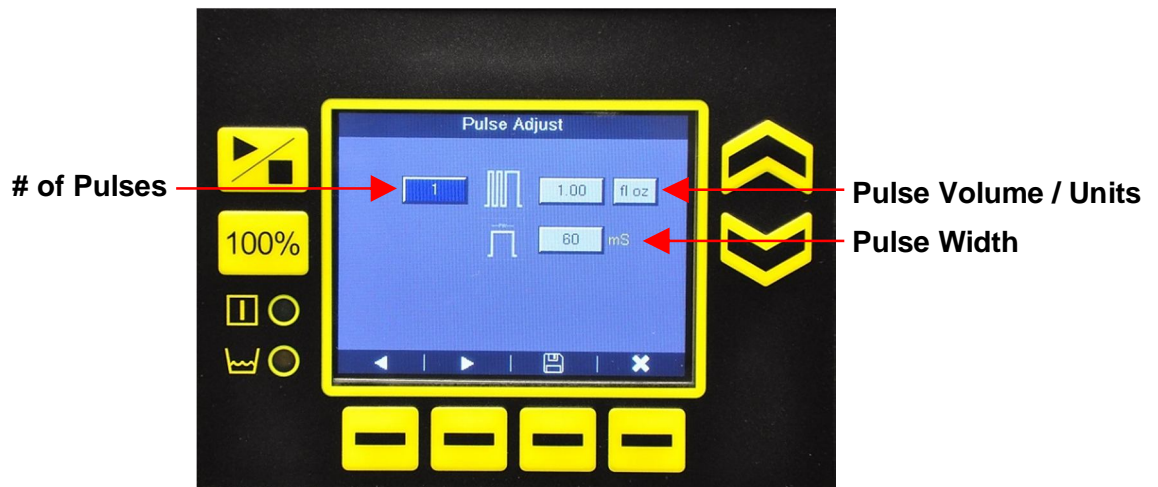







Figure 4: Pulse Adjust

| FIELD | ALLOWABLE VALUES |
|-------------|--|
| Pulse Count | 1 - 10000 |
| Volume | 0.1 - 10000 |
| Units | fl. oz. – GAL or mL – L (dependent on units setting) |
| Pulse Width | 4 mS – 60 mS |

Refer to the manufacturer’s documentation for information regarding the external device providing the pulse input. In general, larger numbers result in better output resolution. Some devices are capable of operating in varying frequency and pulse widths. The minimum recommended pulse width is 4 mS (milliseconds). Set the pulse width to a value less than the minimum pulse width of the external device. Press **Save**  to retain the entered values, then press **Exit**  to return to the pulse mode home screen, or

press **Exit**  to exit without modifying the parameters. For devices with pulse widths less than 4mS, use digital input DI1.

In pulse mode, when the pump receives a pulse stream, the calculated flow output value will be displayed. The **Start / Stop** button must be pressed or **Remote Start / Stop** activated for the pump to dose at the calculated flow rate. The **Pump Status Indicator** will be illuminated and the pump will operate at the flow rate derived from the pulse mode settings. At least two pulses must be sensed or the **Pulse Not Synced**  icon will appear on the notification bar. If the pulse stream results in a calculated flow rate greater than the pump's calibrated maximum volume the pump will dose at the maximum flow rate and the **Max Pump Volume Exceeded**  icon will appear in the notification bar until the pulse rate decreases.

4.3 Batch Mode

In batch mode, upon receiving a single pulse, the pump delivers the programmed volume of fluid in the programmed amount of time.

| FIELD | ALLOWABLE VALUES |
|----------------------------|---|
| Batch Volume | 0.01 to 10,000 (current version only 9999.90) |
| Units | Fl oz/GAL or mL/L depending on units setting |
| Dosing Time (Seconds) | 1 to 86400 |
| Calculated Flow Rate | 0.001 to Maximum Capacity |
| Pulse Width (Milliseconds) | 4 to 60 |

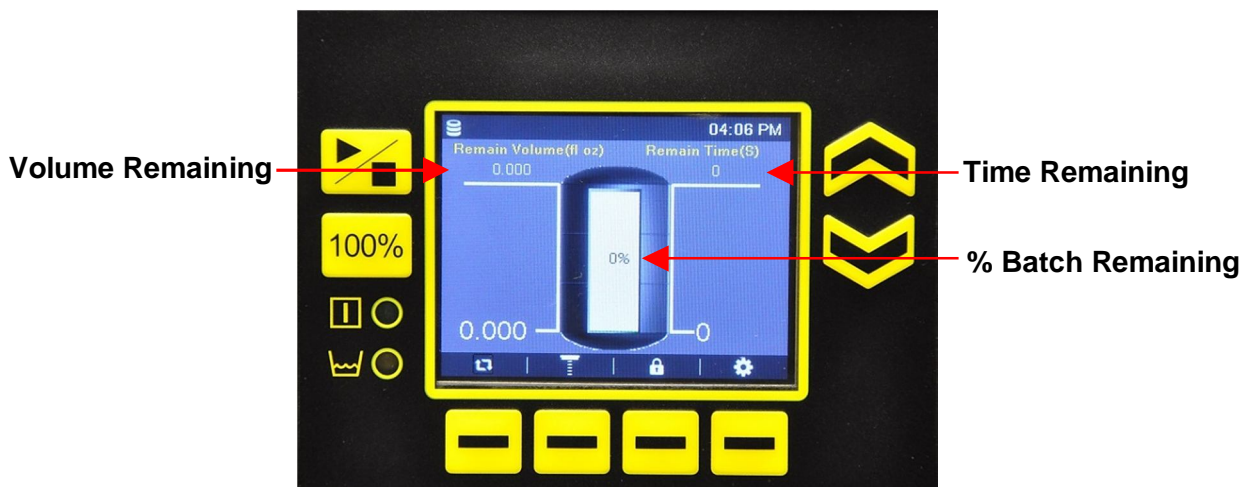



Figure 5: Batch Mode Home Screen

1. From the Batch Mode home screen (Figure 5) press the **Up** or **Down** buttons to go to the Batch Adjust screen (Figure 6).

2. Enter the values for the quantity and units of the volume of fluid to be dosed (Figure 6).

NOTE: If a set of entered values results in a condition that exceeds the pump's maximum calibrated flow, the field will be highlighted red. Increase or decrease this or one of the other parameters to clear the condition.

3. Enter the pulse width after consulting the documentation for the device that will generate the pulse.
4. Select the **Pulse Accumulator** feature, as needed.
5. Press **Save**  and **Exit**  to return to the Batch Mode home screen.
6. Press the **Start / Stop** button, the Pump Status Indicator will glow green, and the pump will be ready to receive and act upon an incoming pulse.

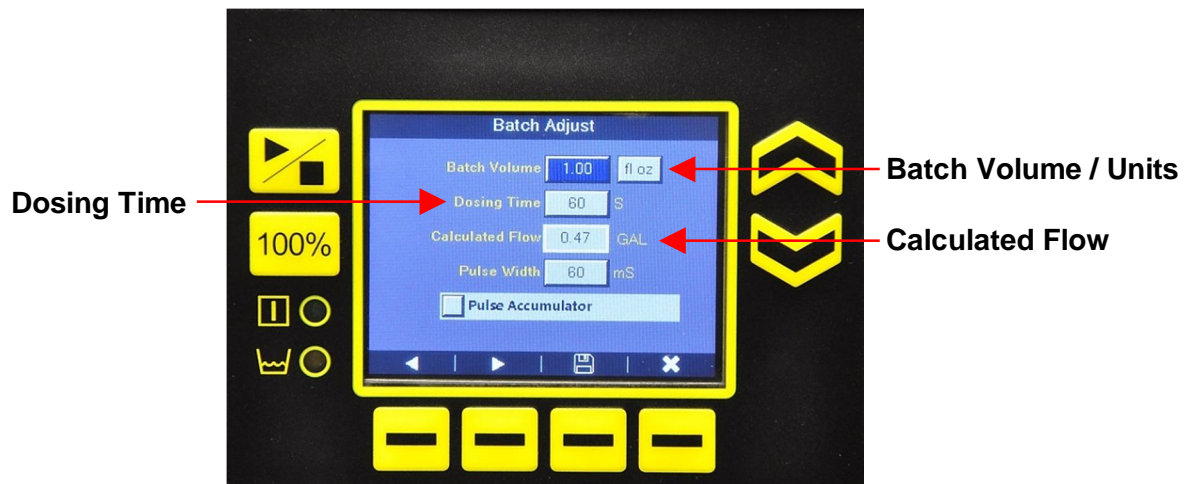



Figure 6: Batch Adjust

Once the pump is started and one a pulse is received, the **Dosing**  icon will appear in the notification bar. If the pump receives a pulse before the current batch is complete and the **Pulse Accumulator** box is checked, the pump will accumulate input pulses and finish the current batch before moving on to the next. The display screen will show the remaining batch volume, time, and %.

If the pump receives a pulse before the current batch is complete and the **Pulse Accumulator** box is not checked, the current batch is reset and a new batch starts immediately.

4.4 Cycle Timer

The cycle timer allows the user to establish a continuously repeating cycle of pump on and off times.

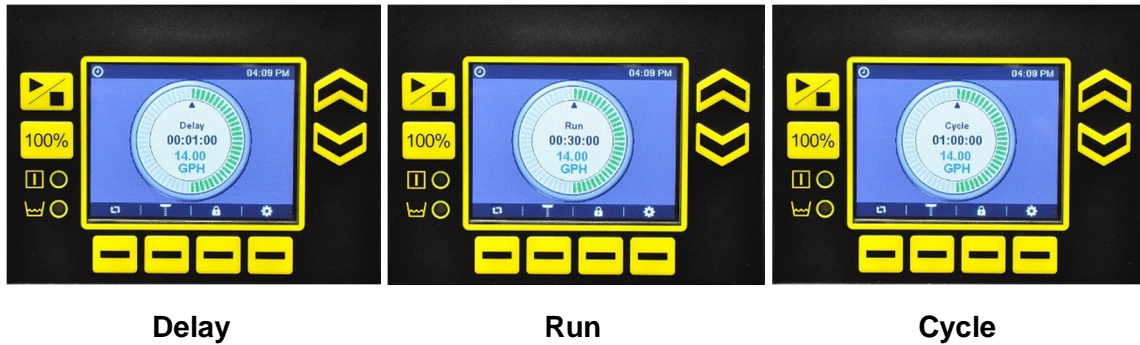

Figure 7: Cycle Timer Home Screen

1. From the cycle timer home screen (Figure 7) press the **Up** or **Down** buttons to access the cycle timer adjust screen (Figure 8).
2. Enter the desired values for delay, duration and cycle times by pressing **Left** ◀ or **Right** ▶ to navigate between fields.

NOTE: Delay is the time before the initial cycle starts, Duration is the time in which the pump is operating, and Cycle is the duration plus off time before the next cycle starts.

3. Enter the desired flow rate.

NOTE: If a set of entered values results in a calculated flow that exceeds the pump's maximum calibrated flow, the calculated flow field will be highlighted red. Modify one or more of the parameters until the calculated flow rate is within the pump's flow range to clear the condition (Figure 8).

4. Press **Save**  and **Exit**  to return to the home screen.

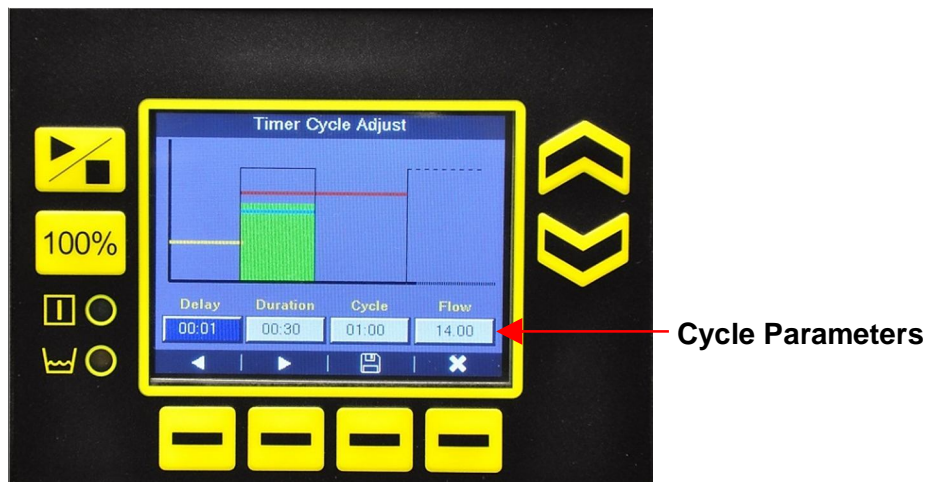

Figure 8: Cycle Timer Adjust

| FIELD | ALLOWABLE VALUES |
|-------------------|--------------------------------|
| Delay (hr:min) | 0:01 to 23:59 |
| Duration (hr:min) | 0:01 to (Cycle setting - 0:01) |
| Cycle (hr:min) | 0:01 to 23:59 |
| Calculated Flow | 0.1 to Maximum Capacity |

The clock starts when the **Start / Stop** button is pressed or a remote start signal is received. Pressing the **Start / Stop** button or toggling the **Remote Start / Stop** input while the cycle timer process is running will cancel the process. Starting the pump again will restart the process from the beginning, including delay. The delay will only be active during the initial cycle and will not repeat until the pump has been stopped and restarted. The screen will reflect the current state (delay, run, cycle) and time remaining.

4.5 Timed Event Mode

In timed event mode, four different events can be programmed for each day of the week. Each event consists of a start time, duration and a flow rate. The next event data is displayed on the time event home screen (Figure 9).



Figure 9: Timed Event Home Screen

Before programming, ensure that the Time/Day settings in the pump are correct. (Navigate to **Settings – Time/Day** to update.) From the timed event home screen press the **Up** or **Down** buttons to enter the timed event adjust screen (Figure 10).

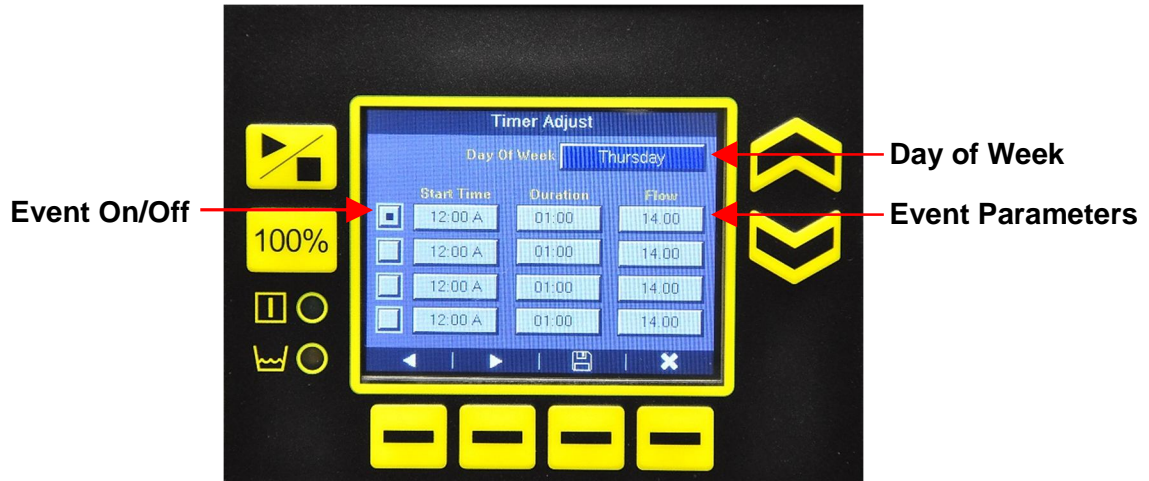

Figure 10: Timed Event Adjust

| FIELD | ALLOWABLE VALUES |
|--------------------------|--------------------------------|
| Start Time (hr:min)AM/PM | 0:01 to 12:00 AM/PM |
| Duration (hr:min) | 0:01 to (Cycle setting - 0:01) |
| Flow Rate | 0.001 to Maximum Capacity |

1. Press **Left** and **Right** to navigate and the **Up** and **Down** buttons to set start time, duration and flow rate. Enter the parameters for as many as four events for each day of the week. The enable/disable column on the left allows multiple choices to be entered (Figure 10).
2. Press the **Up** or **Down** buttons to fill the event on/off box and enable the event.
3. Press **Save** and **Exit** to return to the home screen. Once the settings have been saved, the list will sort in chronological order with events not active appearing below any active events.
4. Press the **Stop / Start** button or assert a remote start to ready the pump. The pump status indicator will illuminate. At the time and day shown for the next event, the pump will start and dose for the programmed amount of time at the programmed flow rate. Once an event has completed, the next active event will be shown on the home screen with the pump idle until the event occurs.

If overlapping events are programmed the active event will be overridden by subsequent timed events.

4.6 Enhanced Control Inputs and Outputs

In addition to the enhanced modes of operation, the enhanced control model pumps include a variety of inputs and outputs to benefit the user.

4.6.1 Inputs

Enhanced control model pumps have four digital and two analog configurable inputs. Digital inputs are labeled DI1 – DI4. Analog inputs are AI1 and AI2. See section 5.0 Cable Wiring, for the cable and pin assignments for each of these inputs.

Each digital input can be assigned to one of five functions or <Disable>. The analog inputs can be assigned one of two functions plus <Disable>. The functions are listed in the table below.

| Input Type | Function | Use |
|----------------|-------------------------------|---|
| Digital | <Disable> | De-activates input |
| | Remote Start/Stop | Externally toggles start/stop |
| | Tank Level Switch – Empty | Triggers “Tank Empty” alarm |
| | Tank Level Switch – Low | Triggers “Tank Low” alarm |
| | Remote Internal/External Mode | Toggles internal/external control |
| | External Control Pacing Pulse | Input signal for Pulse Mode |
| Analog | <Disable> | De-activates input |
| | Pacing | Input signal for Analog Mode |
| | Tank Level | Triggers “Tank Empty” or “Tank Low” alarm |



The Remote Start/Stop, Tank Level Empty and Tank Level Low functions are included in manual control model pumps. The operation of these features is described in the operation manual part number 54038.

4.6.1.1 Remote Internal/External Mode

Pump operation and output flow rate is controlled by either internal (user input/internal timer) or external (outside signal) modes. These modes are listed in the table below.

| Internal Control | External Control |
|------------------|------------------|
| Manual Mode | Analog Mode |
| Cycle Timer Mode | Pulse Mode |
| Timed Event Mode | Batch Mode |

The **Remote Internal/External Mode** toggles the operating mode between internal and external control. The user defines one mode each for internal and external control types.

1. From the settings screen, navigate to **Int/Ext Select** and press **Enter** .
2. Press **Left**  and **Right**  to move between mode choices.
3. The **Up** and **Down** buttons select and de-select modes.

4. Press **Save**  and **Exit** .

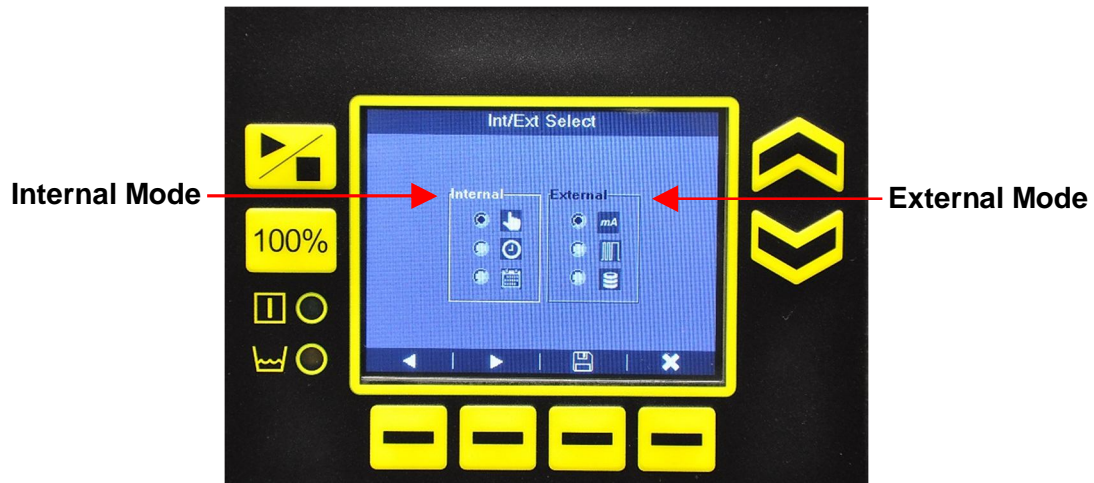

Figure 11: Int/Ext Select

With the selections shown above, the input configured per section 4.6.1.3 Configuring Enhanced Control Inputs, and cable hookups per section 5.0 Cable Wiring, a Remote Internal/External signal will toggle the pump between manual and analog modes.

4.6.1.2 Analog Tank Level Input

Selecting this input overrides the digital tank level empty and tank level low inputs and combines both functions into one analog signal. When the 4 - 20 mA input signal drops to 6.4 mA (15%) the tank level low alarm will be enabled. When it reaches 4.8 mA (5%), the tank level empty alarm will be enabled.

4.6.1.3 Configuring Enhanced Control Inputs

Input signals are assigned on the configure input screen (Figure 12).

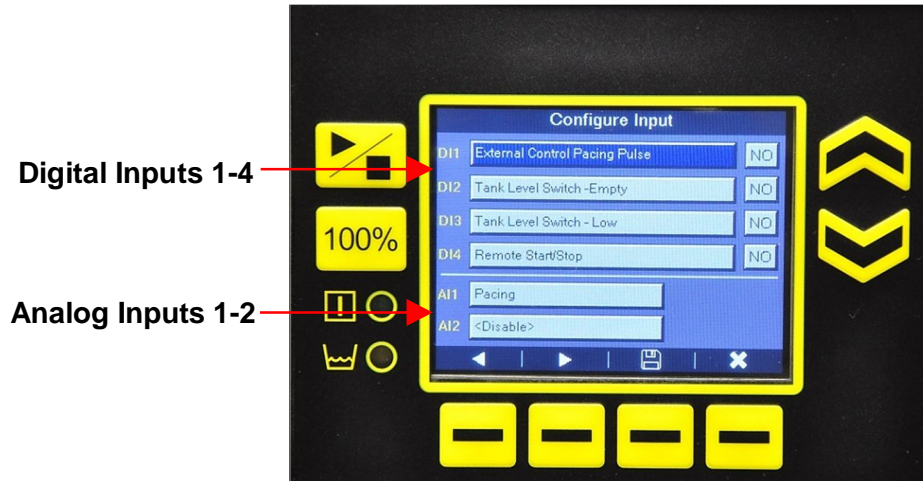





Figure 12: Configure Input

In the **Settings** screen, navigate to configure input and press **Enter** . Press **Left**  and **Right**  to navigate between fields and the **Up** and **Down** buttons to make selections. Each input can be identified as NO (normally open) or NC (normally closed). If testing produces the opposite effect from what is desired, frequently an easy solution is to change the switch type from NO to NC or vice versa. Note that selecting a function for one input makes it unavailable in others.

4.6.2 Outputs

Enhanced control model pumps have two digital and one analog configurable output. Digital outputs are labeled DO1 and DO2. The analog output is labeled AO1. See section 5.0 Cable Wiring, for the cable and pin assignments for each of these outputs.

Each digital output can be assigned to one of eight functions plus <Disable>. The analog output can be assigned one of two functions plus <Disable>. The functions are listed in the table below.

| Output Type | Function | Use |
|----------------|------------------------|---|
| Digital | <Disable> | De-activates input |
| | Stroke Pulse | Indicator pulse when pump strokes |
| | Pump Running | Indicates steadily while pump is dosing |
| | Pump Standby | Pump Start/Stop toggled to Start, not dosing |
| | Alarm Out | Indicates any alarm is active |
| | Internal/External Mode | Indicates if pump control is internal or external |
| | User Alarm Out | Indicates any user-selected alarm is active |
| | Pump Stopped | Pump Start/Stop toggled to Stop |
| | Timed Event | Pump running in response to Timed Event |
| Analog | <Disable> | De-activates input |
| | Flow | 4 – 20 mA output correlates to 0 – max capacity |
| | Mirror Input AI1 | Transmits AI1 input signal without change |

4.6.2.1 Stroke Pulse

Each time the pump completes a single stroke, a pulse is sent out on the assigned pin. This can be used as an indicator or to trigger other actions. The pulse width is 100ms.

4.6.2.2 Pump Running

Similar to section 4.6.2.1 Stroke Pulse, the pump running output indicates the pump is currently dosing. However, instead of a pulse the output remains active as long as the diaphragm is moving.

4.6.2.3 Pump Standby

Standby is a state in which the **Start / Stop** button has been pressed to start the pump, or a **Remote Start / Stop** signal has been received, and the pump status indicator is green, but the pump is not running. Examples are waiting for an input trigger pulse in batch mode or waiting for a timed event to begin in timed event mode. The pump standby output is an indication of this state.

4.6.2.4 Alarm Out





This output becomes active when any alarm state occurs.

4.6.2.5 Internal/External Mode

The state of this output indicates whether the pump is operating in internal mode or external mode. (See section 4.6.1.1 Remote Internal/External Mode for definitions.) When configured as a NO output, open contacts indicate the pump is operating in internal mode and closed contacts indicate the pump is operating in external mode.

4.6.2.6 User Alarm Out

Similar to 4.6.2.4 Alarm Out, user alarm out becomes active when any alarm state *that the user has selected* occurs.

1. To configure, from the settings screen navigate to **Alarm Set** (Figure 13) and press **Enter** .
2. Navigate to the desired alarm icon by pressing **Left**  or **Right** .
3. Enable or disable alarms using the **Up** and **Down** buttons.
4. Continue with this process until all desired alarms are selected.
5. Press **Save**  and **Exit** .

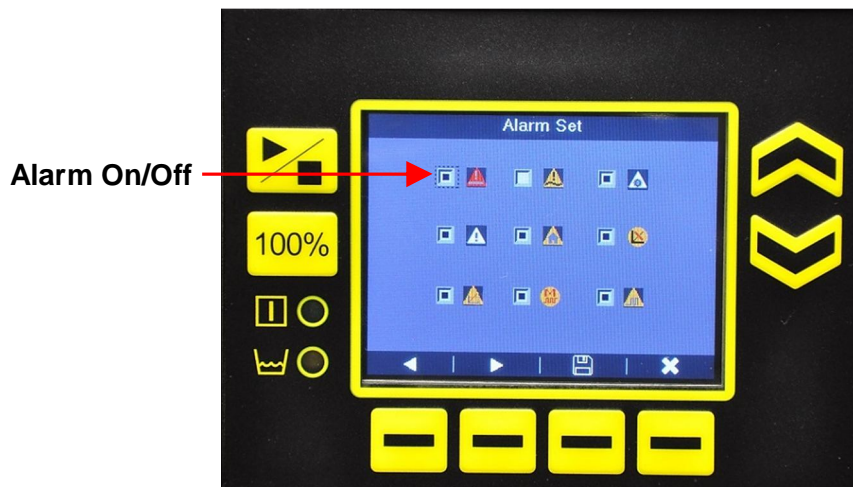











Figure 13: Alarm Set

Table 2: Alarm Icons

| | |
|---|--|
|  | Motor stalling |
|  | System Error (Boot up error) |
|  | Analog pacing signal - loss of signal |
|  | Analog pacing signal - signal over range |
|  | Problem homing the motor |
|  | Tank empty |
|  | Tank low level |
|  | Pulse input not synced |
|  | Max pump volume exceeded (in Pulse Mode) |

4.6.2.7 Pump Stopped

This output becomes active when the **Start / Stop** button has been pressed or a **Remote Start / Stop** signal has been received to stop the pump and the pump status indicator is off.

4.6.2.8 Timed Event

Indicates the pump is currently running in response to a pre-programmed timed event.

4.6.2.9 Flow

This is a 4 - 20 mA output signal that tracks from zero to maximum pump capacity. It is intended for use as a remote indication of calculated output.

4.6.2.10 Mirror Input AI1

This output passes the input received from AI1 without changing it. It can be used to simplify signal wiring of multiple pumps.

4.6.2.11 Configuring Enhanced Control Outputs

Output signals are assigned in the configure output screen (Figure 14).

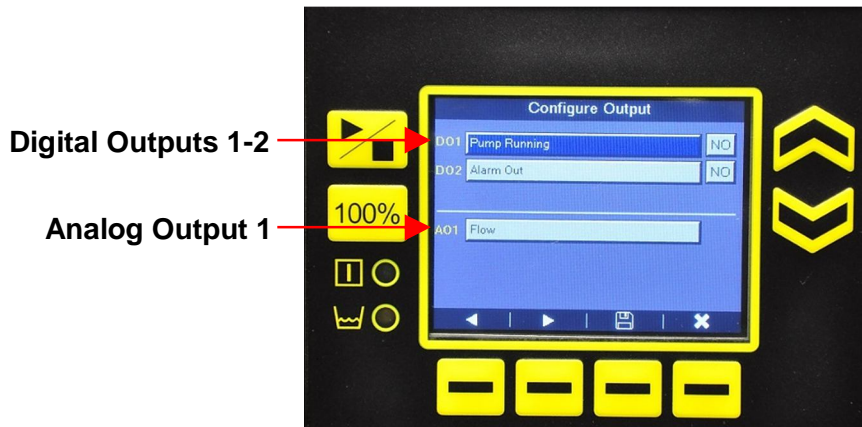







Figure 14: Configure Output

1. In the **Settings** menu, navigate to configure output and press **Enter** .
2. Press **Left**  and **Right**  to navigate between fields and the **Up** and **Down** buttons to make selections. Each output can be identified as NO (normally open) or NC (normally closed). If testing produces the opposite effect from what is desired, frequently an easy solution is to change the switch type from NO to NC or vice versa. Note that selecting a function for one output makes it unavailable in others.
3. Press **Save**  and **Exit** .

5.0 Cable Wiring

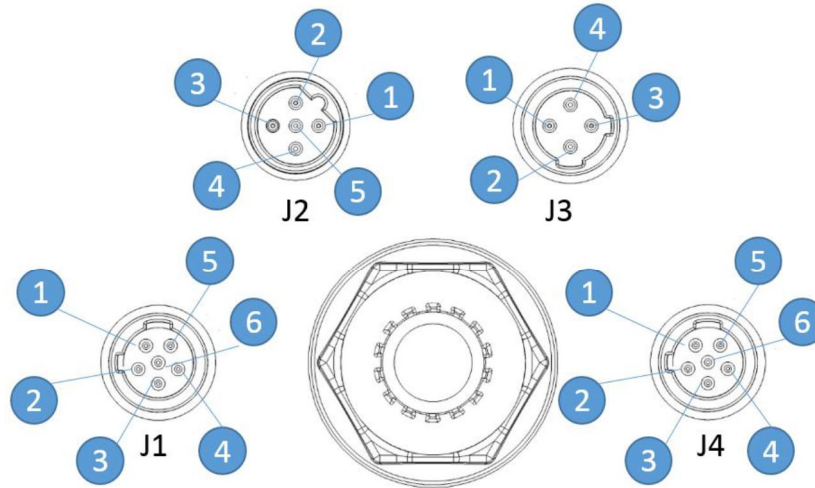

Figure 15: Cable Wiring Diagram

| Connector | Pin # | Input/Output | | Type | Function |
|-----------|-------|--------------|-----------------------|-----------------------|--------------|
| J1 | 1 | DI1 | Input | Digital | Programmable |
| | 2 | DI2 | Input | Digital | Programmable |
| | 3 | DI3 | Input | Digital | Programmable |
| | 4 | DI4 | Input | Digital | Programmable |
| | 5 | - | Power 24V | | |
| | 6 | - | GND | | |
| J2 | 1 | DO1A | Output – N.O. Contact | Digital / Dry Contact | Programmable |
| | 2 | DO1B | Output – N.O. Contact | Digital / Dry Contact | Programmable |
| | 3 | DO2A | Output – N.O. Contact | Digital / Dry Contact | Programmable |
| | 4 | DO2B | Output – N.O. Contact | Digital / Dry Contact | Programmable |
| | 5 | - | No Connect | | |
| J3 | 1 | - | Power 24V | | |
| | 2 | AI1 | Input | Analog | 0/20 mA |
| | 3 | - | Power 24V | | |
| | 4 | AI2 | Input | Analog | 0/20 mA |
| J4 | 1 | AO1 | Output | Analog | 4/20 mA |
| | 2 | - | GND | | |
| | 3 | - | Power 24V | | |
| | 4 | - | GND | | |
| | 5 | - | No Connect | | |
| | 6 | - | No Connect | | |

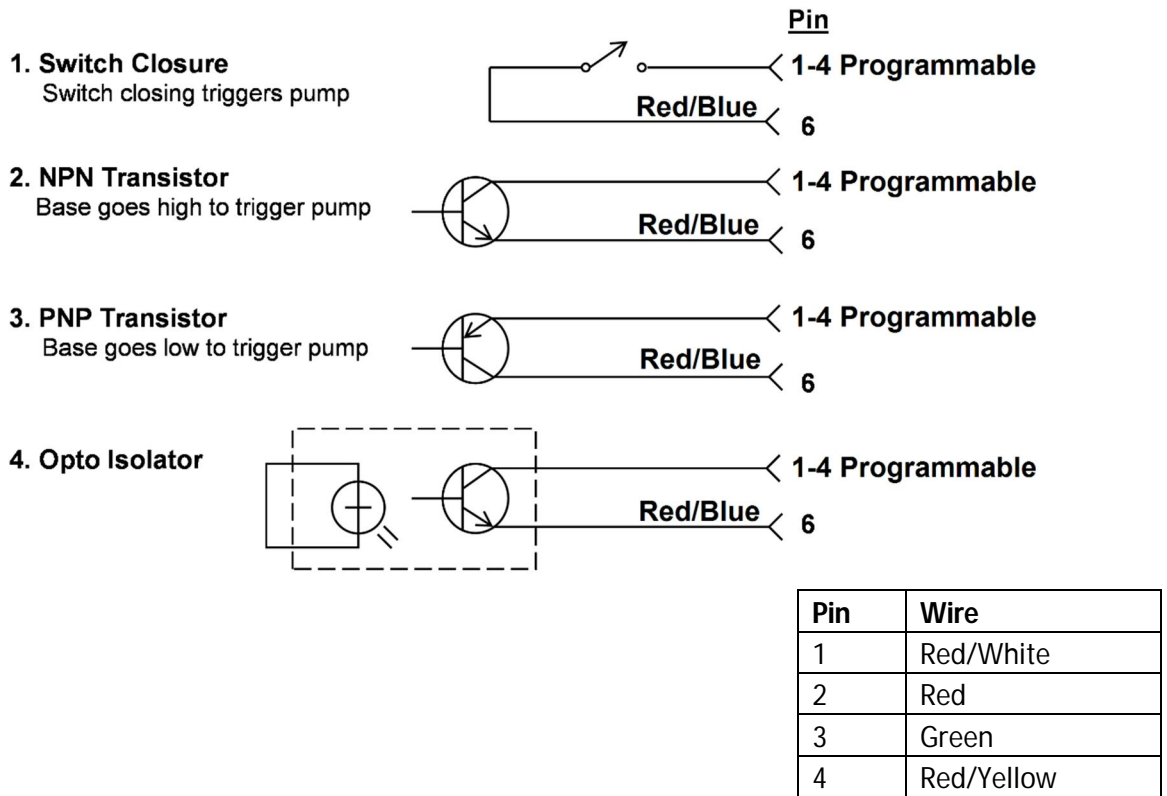

Figure 16: Input Diagram for Digital Inputs DI1 - DI4 (J1)

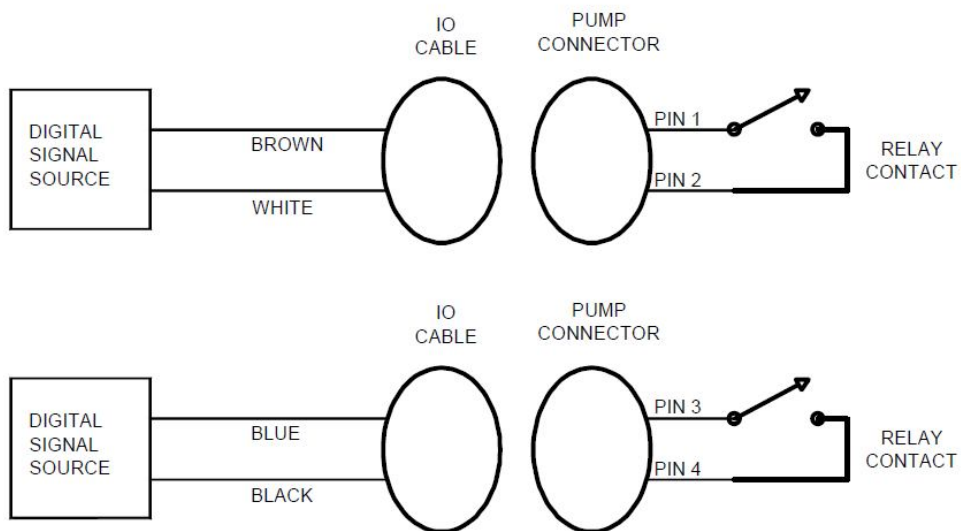

Figure 17: Output Diagram for Digital Outputs DO1 – DO2 (J2)

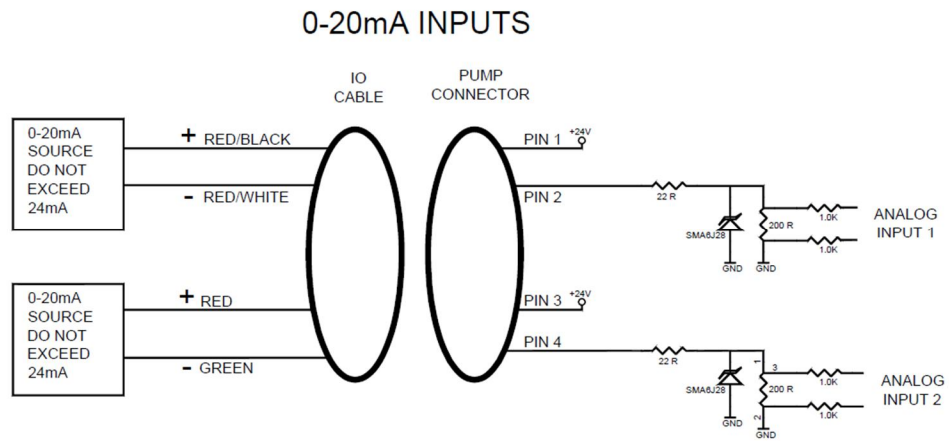

Figure 18: Input Diagram for Analog 0-20mA Inputs AI1 - AI2 (J3)

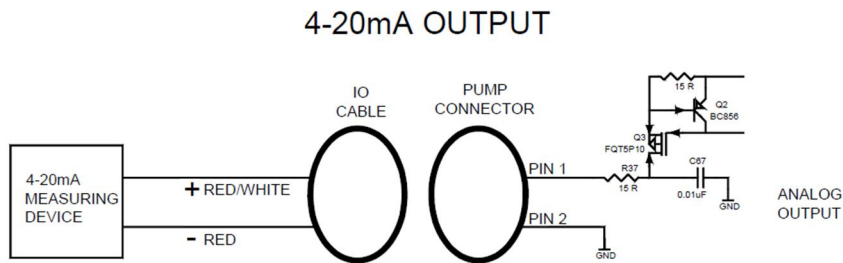

Figure 19: Output Diagram for Analog 4-20mA Output AO1 (J4)

6.0 Troubleshooting

| PROBLEM | POSSIBLE CAUSE | SOLUTION |
|---------------------|---|--|
| Pump Will Not Prime | 1. Pump not turned on or plugged in | 1. Turn on pump/plug in pump |
| | 2. Foot Valve not in vertical position on bottom of tank | 2. Foot valve must be vertical (see section 3.4 Foot Valve / Suction Tubing Installation) |
| | 3. Pump suction lift too high | 3. Maximum suction lift, specified in section 2.1 Specifications. High viscosity liquid handling assemblies require flooded suction |
| | 4. Suction tubing is curved or coiled in tank | 4. Suction tubing must be vertical. Use Milton Roy ceramic weight supplied with pump (see section 3.4 Foot Valve / Suction Tubing Installation) |
| | 5. Fittings are overtightened | 5. <i>DO NOT OVERTIGHTEN FITTINGS!</i> This causes seal rings to distort and not seat properly which causes pump to leak back or lose prime |
| | 6. Air trap in suction valve tubing | 6. Suction tubing should be as vertical as possible. <i>AVOID FALSE FLOODED SUCTION!</i> (see section 3.2.1 Flooded Suction) |
| | 7. Too much pressure at discharge | 7. Shut off valves in pressurized line. Disconnect tubing at injection check valve (see section 4.4.1 Prime Settings). When pump is primed, reconnect discharge tubing |
| | 8. Air leak around fitting | 8. Check for missing or damaged O-rings at ends of fittings |
| Pump Loses Prime | 1. Solution container ran dry | 1. Refill container with solution and re-prime (see Section 4.4.1 Prime Settings) |
| | 2. Foot Valve is not in a vertical position on the bottom of the tank | 2. Foot Valve must be vertical (see section 3.4 Foot Valve / Suction Tubing Installation) |
| | 3. Pump suction lift is too high | 3. Maximum suction lift, specified in section 2.1 Specifications. High viscosity liquid handling assemblies require flooded suction |
| | 4. Suction tubing is curved or coiled in tank | 4. Suction tubing must be vertical. Use Milton Roy ceramic weight supplied with pump (see section 3.4 Foot Valve / Suction Tubing Installation) |

TROUBLESHOOTING

| | | |
|--|---|---|
| | 5. Fittings are over tightened | 5. DO NOT OVERTIGHTEN FITTINGS! This causes seal rings to distort and not seat properly which caused pump to leak back or lose prime |
| | 6. Air trap in suction valve tubing | 6. Suction tubing should be as vertical as possible. AVOID FALSE FLOODED SUCTION! (see Section 3.2.1 Flooded Suction) |
| | 7. Air leak on suction side | 7. Check for pinholes, cracks. Replace if necessary |
| Leakage at Tubing | 1. Worn tubing ends | 1. Cut about 1 in (25 mm) off tubing and then replace as before |
| | 2. Loose or cracked fitting | 2. Replace fitting if cracked. Carefully hand tighten fittings. DO NOT USE PIPE WRENCH. An additional 1/8 or 1/4 turn may be necessary |
| | 3. Worn seal rings | 3. Replace balls and seal rings (see section 5.3 Cartridge Valve and O-Ring Replacement) |
| | 4. Solution attacking Liquid Handling Assembly | 4. Consult your local distributor for alternate materials |
| Low Output or Failure to Pump Against Pressure | 1. Pump's maximum pressure rating is exceeded by injection pressure | 1. Injection pressure cannot exceed pump's maximum pressure. See pump data plate |
| | 2. Worn Seal Rings | 2. Worn seal rings or cartridge valves may need replacement (see section 5.3 Cartridge Valve and O-ring Replacement) |
| | 3. Ruptured Diaphragm | 3. Replace diaphragm (see section 5.2 Diaphragm Replacement) |
| | 4. Tubing run on discharge may be too long | 4. Longer tubing runs may create frictional losses sufficient to reduce pump's pressure rating. Consult factory for more information |
| | 5. Clogged Foot Valve strainer | 5. Remove Foot Valve strainer when pumping slurries or when solution particles cause strainer to clog |
| Failure to Run | 1. Pump not turned on or plugged in | 1. Turn on or plug in pump |
| | 2. Electronic or Mechanical failure | 2. Consult supplier or factory |
| Excessive Pump Output | 1. Syphoning (Pumping downhill without an anti-siphon valve) | 1. Move injection point to a pressurized location or install an anti-siphon valve |
| | 2. Little or no pressure at injection point | 2. If pressure at injection point is less than 30 psi (2.0 Bar), a backpressure valve should be installed |

INTENTIONALLY LEFT BLANK

INTENTIONALLY LEFT BLANK

INTENTIONALLY LEFT BLANK

We are a proud member of Accudyne Industries, a leading global provider of precision-engineered, process-critical, and technologically advanced flow control systems and industrial compressors. Delivering consistently high levels of performance, we enable customers in the most important industries and harshest environments around the world to accomplish their missions.



Proteus is a trademark of Milton Roy, LLC.

info@miltonroy.com
www.miltonroy.com

