

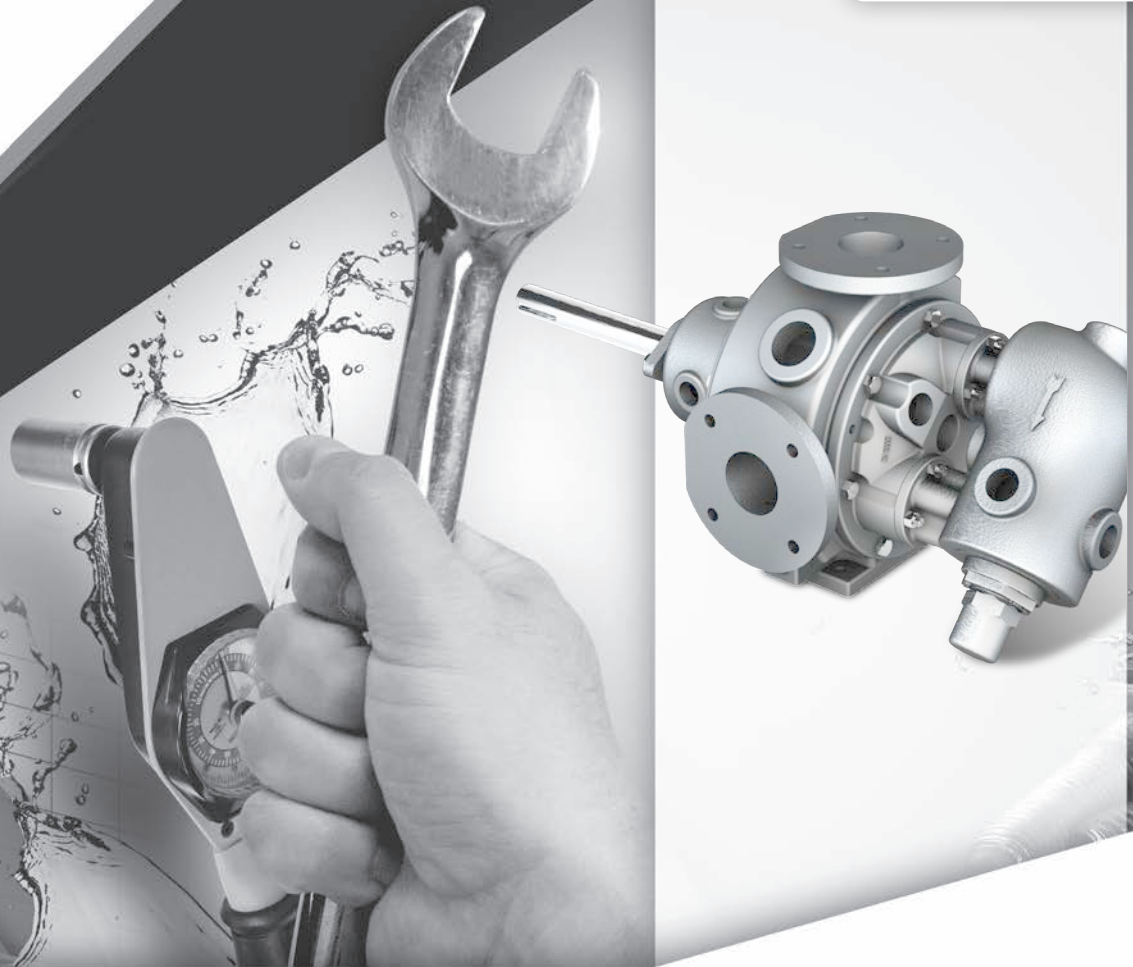

IOM

Installation
Operation
Maintenance
Manual

V Series
Internal Gear Pumps

























Where Innovation Flows

envirogearpump.com



SECTION 1	CAUTIONS—READ FIRST!	1
SECTION 2	PUMP DESIGNATION SYSTEM	2
SECTION 3	HOW IT WORKS—INTERNAL GEAR TECHNOLOGY	4
SECTION 4	SUGGESTED INSTALLATION & OPERATION	5
SECTION 5	MAINTENANCE	8
SECTION 6	DISASSEMBLY	10
SECTION 7	REASSEMBLY	11
SECTION 8	EXPLODED VIEW AND PARTS LISTING	
	V2-55	12
	V2-133	14
	V2-254	16
	V2-423	18
SECTION 9	TROUBLESHOOTING	20

-  **CAUTION:** Only personnel who are familiar with the operation and repair of mechanical products should perform the necessary maintenance. You must familiarize yourself with the entire contents of this manual prior to operating and/or performing any maintenance.
-  **CAUTION:** When selecting a V Series pump for an application, you must first ensure that the pump components are compatible with the process media.
-  **CAUTION:** Prior to startup, review and understand end-clearance adjustments. Following these guidelines will ensure proper end-clearance adjustment avoiding interference between the gears and head. Interference may cause heat generation and premature wear.
-  **CAUTION:** Do not operate this pump in excess of its rated capacity, pressure, speed and temperature.
-  **CAUTION:** Before any maintenance and repair is attempted, disconnect the drive.
-  **CAUTION:** Before any maintenance or repair is attempted, bleed all pressure from the pump through the suction or discharge lines.
-  **CAUTION:** Do not remove any pressure-containing components during pump operation.
-  **CAUTION:** All V Series pumps contain residual hydraulic oil from the factory production test. Hypar-FG 15 food-grade oil is the standard production test fluid, but any certified performance testing may be done on a non-food grade oil, such as Unilube 32 (ISO 32) or Unilube 100 (ISO 100). Determine if this is compatible with the fluid you are pumping. If the fluid is incompatible, then the pump must be fully flushed prior to use.
-  **CAUTION:** When pumping fluids at elevated temperatures, care should be taken to gradually increase temperature. Rapid temperature increase can damage internal components.
-  **CAUTION:** Ensure that the pump has cooled to a safe temperature before any maintenance or repair is attempted.
-  **CAUTION:** When pumping fluids at elevated temperatures the piping may expand, resulting in excessive stress on the pump. This can cause pump failure. Care must be taken when considering pipe design to avoid damage from thermal expansion.
-  **CAUTION:** Do not run the pump dry. This can cause damage to internal components and generate heat, creating a hazardous condition for volatile fluids.
-  **CAUTION:** Prevention of static sparking – If static sparking occurs, fire or explosion could result. Pump, valves and containers must be grounded to a proper grounding point when handling flammable fluids and whenever discharge of static electricity is a hazard.
-  **CAUTION:** The packing in a packed pump is designed to leak. Therefore, when pumping hazardous liquids, a mechanical seal is recommended to minimize any potential source of leakage that could result in a hazardous condition.
-  **CAUTION:** Do not adjust packing while pump is in operation.
-  **CAUTION:** All inlet and discharge plumbing should be clean and free from foreign material prior to startup of pump.
-  **CAUTION:** Keep hands and fingers away from any pump opening while the pump is connected to the drive.
-  **CAUTION:** When connecting to an electric motor, follow all safety recommendations provided by the motor manufacturer.
-  **WARNING:** In any positive-displacement pump system, a reliable pressure-protection device must be used in the discharge piping to avoid a dangerous pressure increase, which could cause the pump or any component in the discharge piping to burst and can lead to serious injury. A pump-mounted integral relief valve is not intended to be used in this manner.
-  **CAUTION:** Never remove safety guards from shafts, couplings, V-belts or pulleys during operation. Doing so could result in injury.
-  **CAUTION:** When pumping high-temperature fluids, avoid contact with the pump. Serious injury could occur.
-  **CAUTION:** Do not wear loose or dangling clothing or jewelry near the equipment. These items could become caught in the equipment and cause injury.
-  **CAUTION:** Before any maintenance or repair is attempted, ensure that the pump has been thoroughly flushed of any hazardous fluids. Review the Material Safety Data Sheet (MSDS) applicable to the fluid for proper handling.

EXAMPLE:
V2-55WDA/2.5ART/BPGNA/16/CHV

V2- MODEL	EXTERNALS	INTERNALS	CLEARANCE /	PORTS	ORIENTATION /	BUSHINGS	SEAL TYPE/ MATERIAL	SEAL FACES /	RELIEF VALVE	JACKET OPTIONS
55	W	D	A	2.5A	RT	B	PG	NA	N = NO RELIEF VALVE	CHV
133			B	3A	LT	T	PW	NS	05	CHN
254			C	4A	TR	I	3T	SCA	06	CNV
423				5A	TL	X		SCC	07	CNN
									08	
									09	
									20	
									13	
									14	
									16	

MATERIAL CODES

MODELS

V2-55 = 55 in³/rev
V2-133 = 133 in³/rev
V2-254 = 254 in³/rev
V2-423 = 423 in³/rev

MATERIAL (EXTERNAL):

W = CAST IRON

MATERIAL (INTERNAL):

D = DUCTILE IRON

CLEARANCES (NT1-55/133/254/423):

A = [$< 1,600$ cSt, $<232^{\circ}\text{C}$ ($<450^{\circ}\text{F}$)]
B = [$1,600$ - $16,000$ cSt, $<232^{\circ}\text{C}$ ($<450^{\circ}\text{F}$)]
C = [$16,000$ - $54,000$ cSt, $<232^{\circ}\text{C}$ ($<450^{\circ}\text{F}$)]

PORTS

2.5A = 2.5" ANSI
3A = 3" ANSI
4A = 4" ANSI
5A = 5" ANSI

ORIENTATION (when looking from the shaft)

RT = Right Suction, Top Discharge
LT = Left Suction, Top Discharge
TR = Top Suction, Right Discharge
TL = Top Suction, Left Discharge

BUSHINGS

B = Bronze bushings
T = Tungsten carbide bushings
I = Hardened cast iron bushings
X = No bushing (Customer Supplied)

SEAL TYPE/MATERIAL

PG = Packing (PTFE-GRAPHITE)
PW = Packing (Wedgee)
3T = Triple Lip Seal (PTFE)

SEAL FACES

NA = NOT APPLICABLE (PACKING)
NS = NO SEAL (Customer Supplied)
SCA = Silicone Carbide/Aflas
Elastomers
SCC = Silicone Carbide/Chemraz
Elastomers

RELIEF VALVE (V2-55):

N = NO RELIEF VALVE
06 = 20 to 60 psi
09 = 61 to 90 psi
16 = 91 to 160 psi

RELIEF VALVE (V2-133):

N = NO RELIEF VALVE
05 = 20 to 50 psi
08 = 51 to 80 psi
13 = 81 to 130 psi

RELIEF VALVE (V2-254):

N = NO RELIEF VALVE
06 = 30 to 60 psi
10 = 61 to 100 psi
14 = 101 to 140 psi

RELIEF VALVE (V2-423):

N = NO RELIEF VALVE
07 = 40 to 70 psi
12 = 71 to 125 psi

JACKET OPTIONS:

CHV = Case jacketed (C), head jacketed (H), valve jacketed (V)
CHN = Case jacketed (C), head jacketed (H), valve non-jacketed (N)
CNV = Case jacketed (C), head non-jacketed (N), valve jacketed (V)
CNN = Case jacketed (C), head non-jacketed (N), valve non-jacketed (N)

SIZES AVAILABLE

Pump Model	Port Sizes ¹	Pump Only
V2-55	2-1/2" ANSI	82 kg (180 lb)
V2-133	3" ANSI	160 kg (350 lb)
V2-254	4" ANSI	240 kg (530 lb)
V2-423	5" ANSI	340 kg (750 lb)

¹ Flanged connections meet Class 125# ANSI

PUMP SELECTION PERFORMANCE CRITERIA

Model	Nominal Pump Rating		¹ Max. Discharge Pressure	Max. Temperature
	rpm	m ³ /h (gpm)	bar (psig)	Celcius (Fahrenheit)
V2-55	420	20 (90)	6.9 (100) >20 cSt	232° (450°)
V2-133	350	45 (200)	5.2 (75) >20 cSt	232° (450°)
V2-254	280	64 (280)	5.2 (75) >20 cSt	232° (450°)
V2-423	280	102 (450)	5.2 (75) >20 cSt	232° (450°)

¹Maximum pressure listed reflects maximum differential pressure and maximum allowable working pressure.

²Values listed in table are nominal and for reference only. To ensure proper pump selection, always refer to EnviroGear CHOICE

The V SERIES GEAR PUMP is a rotating, positive displacement pump. These drawings show the flow pattern through the pump upon its initial rotation. It is assumed that the pump has no fluid in it prior to its initial rotation.

1 The shaded area indicates the liquid as it is drawn into the liquid inlet port of the pump. As the rotor turns, atmospheric pressure forces the liquid between the rotor teeth and idler teeth. The two arrows indicate the rotational direction of the pump.

2 As the rotor continues to turn, the liquid is forced through the crescent-shaped area of the wetted path. The crescent-shaped area divides the liquid and acts as a barrier between the inlet and discharge ports.

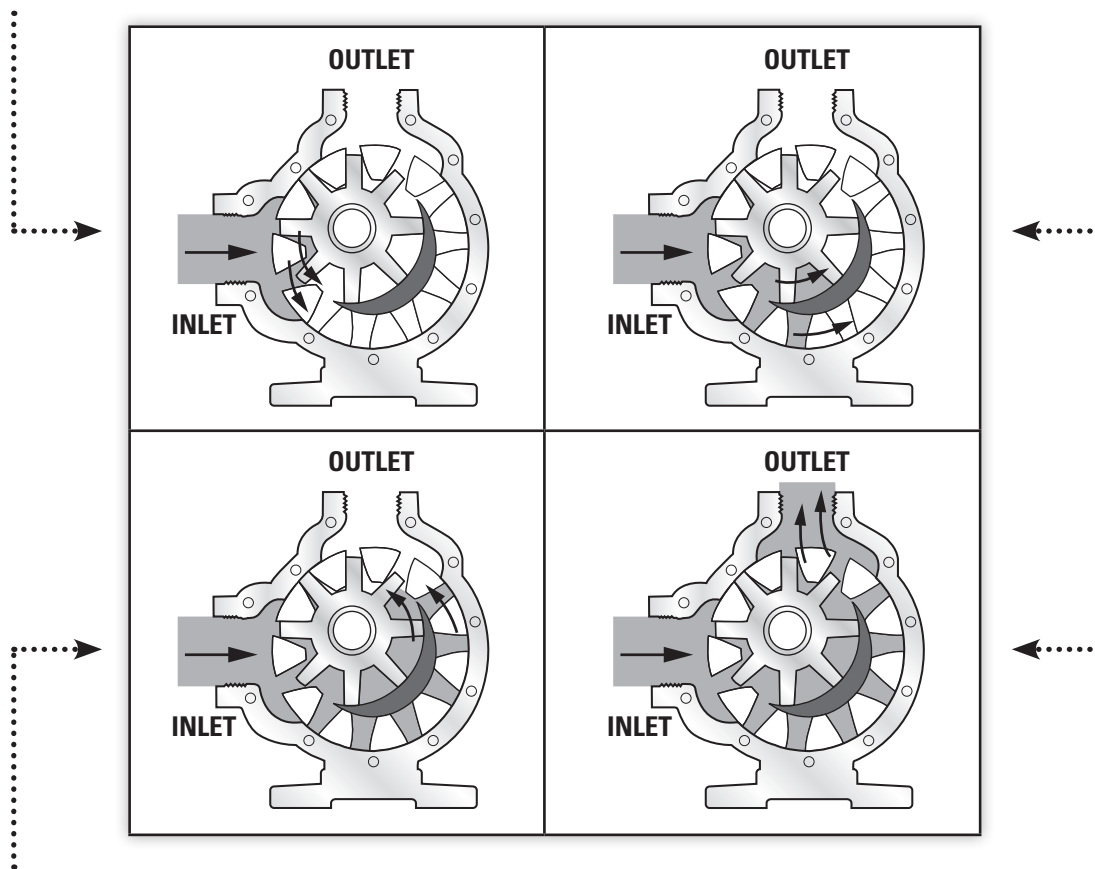

3 As the rotor continues to turn, the liquid is forced past the crescent-shaped area and moves toward the discharge port.

4 As the rotor completes one complete rotation, the rotor and idler teeth interlock, forcing the liquid through the discharge of the pump. The pump may take several rotations to completely prime depending on the conditions of the application.

V Series gear pumps are designed to meet the performance requirements of even the most demanding pumping applications. They have been designed and manufactured to the highest standards and are available in a number of different sizes to meet your pumping needs. Refer to the performance section of this manual for an in-depth analysis of the performance characteristics of your pump.

INSTALLATION

Months of careful planning, study and selection efforts can result in unsatisfactory pump performance if installation details are left to chance.

Premature failure and long-term dissatisfaction can be avoided if reasonable care is exercised throughout the installation process.

LOCATION

Noise, safety and other logistical factors usually dictate where equipment will be situated on the production floor. Multiple installations with conflicting requirements can result in congestion of utility areas, leaving few choices for additional pumps.

Within the framework of these and other existing conditions, every pump should be located in such a way that key factors are balanced against each other to maximum advantage.

ACCESS

The location of the pumping unit should be accessible. If it's easy to reach the pump for maintenance personnel will have an easier time carrying out routine inspections and adjustments. Should major repairs become necessary, ease of access can play a key role

in speeding the repair process and reducing total downtime.

FOUNDATION

BASEPLATES AND ANCHORS:

The preferred mounting for a baseplate is on a concrete pad with grouting. No matter how robust the design, there is always some flexibility in the baseplate itself. If there is insufficient support under the baseplate, it can distort causing alignment difficulties and normal vibrations can be amplified to unacceptable levels through resonance in the pump support and/or piping. A properly grouted baseplate will resist distortion and will provide sufficient mass to dampen any vibration.

NOTE: When pumps and motors are assembled on a baseplate at the factory, a preliminary alignment is done to ensure that the pump and motor can be aligned at its installation. This alignment is not to be considered as a final alignment. The factory alignment can, and does, change during shipment and when the pumping unit is installed. Actually, several alignments are necessary as will be described later.

Anchor (foundation) bolts are used to hold the baseplate to its support structure, whatever that may be. In the preferred case of mounting the pump unit on a concrete pad, the anchor bolts are set into the pad as indicated in the following illustration. When pouring the pad, it's helpful to have a wooden template attached to the foundation form to position the anchor bolts at their locations as indicated on the pump unit assembly drawing.

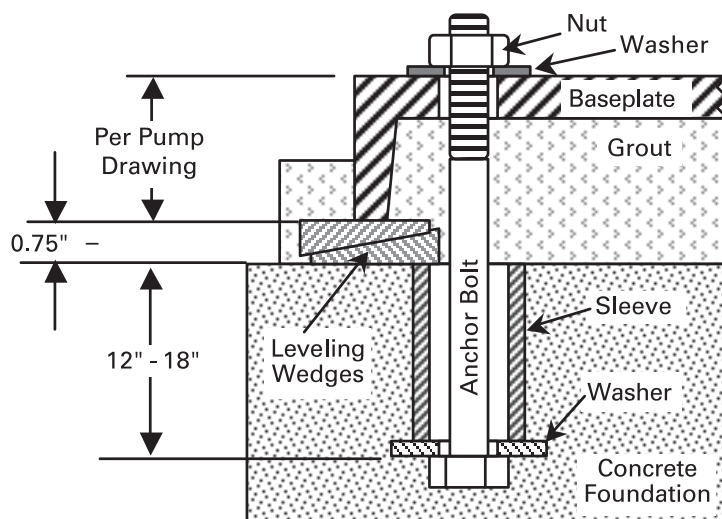

FIGURE A – TYPICAL ANCHOR BOLT (SLEEVE TYPE)

Anchor bolts are usually sized smaller than the anchor bolt hole size in the base. Calculate bolt length as indicated in the Figure A on the left.

The ID of the sleeve should be two bolt sizes larger than the anchor bolt.

Allow approx. $\frac{3}{4}$ " - $1\frac{1}{2}$ " space between the bottom edge of the baseplate and the foundation for grouting.

A "Sleeve" type anchor bolt is shown here. Alternatively, a "hook" or "J" type anchor bolt may be used.

Pack the space between the anchor bolt and sleeve to prevent concrete and/or grout from entering this area.

BASE INSTALLATION AND GROUTING:

NOTE: Before the baseplate is installed, it is advisable to thoroughly clean the underside to enable the grouting to adhere to it. Do not use oil-based cleaners since grout will not bond to it.

Once the concrete pad has cured, the baseplate can be carefully lowered over the anchor bolts.

Place shims or tapered wedges under the baseplate at each of the anchor bolt positions to provide about 0.75" – 1.50" clearance between the base and the foundation. Adjust shims/wedges to level the baseplate. **Since there may be some flexibility in the baseplate, we must perform an initial alignment prior to grouting to ensure that a final alignment can be achieved. See section covering Alignment of Pump/Driver Shafts.** Potential problems here include bowing and/or twisting of the baseplate. If gross misalignment is observed, shims/wedges may have to be added under the mid-point of the base or the shims/wedges at the corners may have to be adjusted to eliminate any twist. If the driver feet are bolt-bound for horizontal alignment, it may be necessary to loosen the pump hold-down bolts and shift the pump and driver to attain horizontal alignment. When alignment has been achieved, lightly tighten the anchor bolts. The anchor bolts should not be fully tightened until the grout has set.

Grouting furnishes support for the pump unit baseplate providing rigidity, helping to dampen any vibration and serves to distribute the weight of the pump unit over the foundation. To be effective, grouting must completely fill all voids under the baseplate. For proper adhesion or bonding, all areas of the baseplate that will be in contact with the grout should be thoroughly cleaned. See note above. The grout must be non-shrinking. Follow the directions of the grout manufacturer for mixing. Proceed with grouting as follows:

NOTE: If the size of the equipment or the layout of the installation requires it, grouting can be done in two steps as long as the first step is allowed to cure completely before the second step is applied

1. Build a sturdy form on the foundation around the baseplate to contain the grout.
2. Soak the top of the concrete foundation pad thoroughly. Remove surface water before pouring.
3. Pour the grout through the hole(s) in the top and/or through the open ends of the channel steel baseplate, eliminating air bubbles by tapping, using a vibrator or pumping the grout into place. If necessary, drill vent holes into the top of the base to evacuate air.

4. Allow grout to set completely, usually a minimum of 48 hours.
5. Tighten foundation anchor bolts.
6. Recheck alignment to ensure that there have been no changes.
7. After the grout has dried thoroughly, apply an oil base paint to shield the grout from air and moisture.

PIPING

Final determination of the pump site should not be made until the piping challenges of each possible location have been evaluated. The impact of current and future installations should be considered ahead of time to make sure that inadvertent restrictions are not created for any remaining sites.

The best choice possible will be a site involving the shortest and straightest hookup of suction and discharge piping. Unnecessary elbows, bends and fittings should be avoided. Pipe sizes should be selected to keep friction losses within practical limits.

All piping should be supported independently of the pump. In addition, the piping should be aligned to avoid placing stress on the pump fittings. To eliminate possible closing of the line when performing pump maintenance, a gate valve should be installed at the suction line.

V Series gear pumps are positive displacement pumps; as such, care must be used in protecting piping and components used in your system. Pumps equipped with an internal relief valve are designed to protect the pump only. A system relief valve should be installed along with the pump's internal relief valve.

When placing the pump, choose a location as close to the product source as possible. Care should be taken in your supply line to avoid cavitation due to viscosity and suction lift. **NOTE:** Some liquids may become thicker with temperature changes. Please refer to your supplier of product being pumped for information on viscosity changes due to temperature. Avoid air pockets on suction side of pump when designing piping layout. This will also reduce the possibility of cavitation. The weight of the piping should not be supported or absorbed by the pump. Suction and discharge piping should be supported by pipe hangers or another suitable means.

V Series pumps are not suited for pumping dirty, solid-laden liquids unless special provisions are made. Contact the factory for guidance.

A strainer should be used on the suction side of the pump. The strainer should consist of an adequate size mesh screen as to not cause excessive friction loss. It is suggested that a maintenance program is created to assure that the inlet strainer remains free of obstructions and blockage.

PORT ORIENTATION AND SHAFT ROTATION:

V Series pumps can be operated in either a clockwise or counterclockwise rotation. The shaft rotation determines which port is suction or discharge.

PRESSURE RELIEF VALVES:

- V Series pumps are positive displacement pumps, which means the system must have provisions for pressure relief protection, such as a relief valve mounted directly on the pump or inline with the system. Alternatively, the system can be installed with a torque-limiting device or a rupture disk.
- If the system requires the pump to operate in both directions, pressure relief protection is required on both sides of pump.
- When using an integral relief valve, the adjusting screw cap must always point towards the suction side of pump. If shaft rotation has to be reversed, simply remove the pressure relief valve and reinstall it in the proper configuration to avoid over-pressurization of the system.
- Pressure relief valves are not intended to control pump flow or regulate discharge pressure.
- The pump-mounted integral relief valve should never be relied upon for system protection.

START UP

- Check to ensure that the pressure/vacuum gauges are installed on inlet and discharge side of the pump.
- Check to ensure that installation and piping are correctly fastened and supported.
- Check to ensure that the pump and driver are properly aligned.
- Verify that the motor is wired correctly. Check to ensure that the thermal overload relays are properly sized and set for operation.
- With motor/driver locked out, check that the pump rotates by hand.

- Jog motor to validate correct rotation.
- Check to ensure that the coupling guard and all other safety-related devices and instrumentation are in place and in working order.
- Check to ensure that the pressure relief valve is installed correctly.
- Lubricate any grease fittings and/or bearings.
- Open suction, discharge and any auxiliary valves, such as in-line PRV loops, to ensure proper flow into and out of pump.
- Prime pumping chamber and seal chamber, if possible.
- Gradually warm the pump to the required operating temperature to achieve the proper fluid viscosity.

WARNING: If the pump is not uniformly heated, and the fluid has not reached the viscosity that the pump was designed to handle, pump failure can occur.

- Start pump. If flow is not achieved in 30 seconds shut-off immediately. "Dry" running a pump for extended periods of time will damage the pump. If fluid does not start to flow in 30 seconds, revisit the previous steps.

If every step has been followed, manually fill the pump with the process fluid or a lubricating fluid compatible with the process and restart the pump. If no fluid is flowing within 30 seconds shut the pump down and proceed to trouble shooting section of this document.

- Once pump is operational, listen for any untoward noise, check for any significant vibration or indications of binding. If any of these are observed, the pump should be stopped immediately and a thorough check of the installation should be made to determine the cause. Correct any fault(s) prior to re-starting the pump.
- Check the shaft seal. If pump has a triple-lip seal or mechanical seal, there should be no visible leakage. If pump has packing, there should be a steady leakage stream. Packing leakage should be reduced gradually by tightening the gland nuts ¼-turn at a time until a leakage rate of 40-60 drops per minute is achieved. This may take several hours and several adjustments, but it is required to ensure adequate packing and shaft life.

GENERAL MAINTENANCE

CLEANING: V Series pumps must be maintained and kept as clean as possible. This will allow for quick inspection, adjustment and repair work.

LUBRICATION: Use multi-purpose NLGI #2 grease on all lubrication fittings every 500 hours of operation. Do not over-grease. Applications involving extreme temperatures (high or low) may require other types of lubrication. Consult factory for specific lubrication recommendations.

END PLAY ADJUSTMENT: Frictional wear on internal components of the pump may result in loss of pressure/flow in service due to slip. Pump performance can be improved by adjusting the end play (see Section 7 for "WET END ASSEMBLY").

STORAGE: If a pump is to be stored for more than six (6) months, the pump must be drained prior to storing. A light coat of light oil should be applied to all internal pump parts in order to prevent corrosion. Operators should also lubricate the fittings and apply grease to the pump shaft, while periodically rotating the pump shaft by hand one (1) complete revolution every 30 days to circulate the oil. Be sure to inspect the fastener torque before putting the pump in service after being stored.

STANDARD PACKING MAINTENANCE

PACKING ADJUSTMENT: Newly packed pumps require initial packing adjustments to control leakage. Small initial adjustments are needed to prevent over-tightening of the packing gland. After initial startup, additional adjustments may be required. Finally, the packing should also be checked periodically and adjusted as needed. Refer to Section 4 for "START UP" section for more detail.

REMOVAL:

1. Remove packing gland fasteners.
2. Slide the packing gland along the shaft out of the stuffing box.
3. Remove the packing.
4. Remove packing retaining washer.

INSTALLATION:

1. Ensure packing is chemically compatible with the liquid being pumped; consult with factory recommendations.
2. Install packing retaining washer in the stuffing box.
3. Lubricate packing rings with oil, grease or graphite to aid with assembly.
4. Stagger the packing joints from one side of the shaft to the other. The joints of adjacent strands should never be in line with each other.
5. Install the packing gland and nuts.
6. Ensure that the gland is installed squarely and the nuts are tightened evenly.
7. Tighten the nuts until packing gland contacts packing. Final adjustment should be made per Section 4 "START UP" procedure.

WEDGE PACKING MAINTENANCE

Wedgee packing sets eliminate the clearance gap at the bottom of pump stuffing box bore and provides a positive interference fit against the shaft to prevent solids from penetrating into the packing.

Proper installation of the wedgee on the pump is important to achieve the maximum efficiency of operation. Periodic packing adjustment and inspection procedures are similar to the standard packing procedures.

REMOVAL:

1. Remove packing gland fasteners.
2. Slide the packing gland along the shaft out of the stuffing box.
3. Remove the packing rings.
4. Remove the two-piece wedge seal
5. Remove packing retaining washer.

INSTALLATION:

1. Ensure wedgee packing material is chemically compatible with the liquid being pumped; consult with factory for recommendations.
2. Install packing retaining washer into the stuffing box sliding over the shaft.
3. Install the male component of the two-piece wedge seal by spreading apart at the split and slipping over the shaft. The flat side of the male component faces the packing retaining washer.
4. Next, install the female component of the two-piece wedge seal so that both parts fit together like a single unit.
5. Lubricate packing rings with compatible oil, grease or graphite to aid with assembly.
6. Stagger the packing joints from one side of the shaft to the other. The joints of adjacent strands should never be in line with each other.
7. Install the packing gland and nuts.
8. Ensure that the gland is installed squarely and the nuts are tightened evenly.
9. Tighten the nuts until packing gland contacts packing. Final adjustment should be made per Section 4 "START UP" procedure.

CARTRIDGE TRIPLE-LIP SEAL MAINTENANCE

EnviroGear offers a cartridge triple-lip seal as an alternative for packing. The seal comes pre-lubricated with Magnalube high-temperature grease. Do not remove the plugs from the gland or attempt to install flush lines because this could cause the grease to be lost.

REMOVAL:

1. If installed, disconnect all flush lines or barrier fluid tubes (see Section 6 for "DISASSEMBLY").
2. Loosen the set screws on the seal collar to free the cartridge seal from the shaft.
3. Remove the two (2) fasteners from the seal gland.
4. Slide the cartridge seal out of the stuffing box.

INSTALLATION:

1. Clean the rotor shaft and the seal housing bore (stuffing box) prior to installation. Make sure the sealing surfaces are free of dirt, burrs and scratches. Using emery paper, gently smooth leading edge of the shaft diameter.
2. Lubricate the rotor shaft and inside diameter of the seal generously with light oil.
3. Slide the cartridge seal over the shaft until it contacts the seal chamber face.
4. Install the gland and nuts.
5. Turn the shaft several times while the gland is loose to center the seal.
6. Tighten nuts securely and evenly.
7. Lock the cartridge seal drive collar to the shaft by tightening the set screws evenly. Do not over-torque as this may cause distortion on the collar.
8. Turn the shaft by hand or bump motor in order to test the rotation and to check the drive collar for run-out.

WET END DISASSEMBLY:

1. Remove the screws that hold the head to the casing.
2. Remove the head from the pump using either jacking screws or prying bar. **WARNING:** Protect the idler gear from falling as it may become loose during removal of the head.
3. Remove the idler gear and bushing assembly.
4. Remove the seal or packing set (see Packing and Seal Maintenance section).
5. Loosen the six mounting fasteners that hold the RBS to the casing or adapter plate. Use provided jacking screws if needed.
6. Carefully remove the rotor/shaft assembly. Threaded screw holes are provided on the end of the rotor for lifting purposes to ease removal.
7. For 55, 133 and 254 size pumps, remove the screws that hold the adapter plate to the casing and remove the adapter plate.
8. For 133, 254 and 423 size pumps, remove the thrust washers from the rotor/shaft assembly and rotor bearing sleeve assembly.
9. Clean all parts thoroughly and examine the parts for wear or damage. Replace RBS bushings, thrust washers and idler pin, as necessary.

PRESSURE RELIEF VALVE DISASSEMBLY:

1. Place a mark on the valve and head prior to disassembly in order to ensure proper reassembly.
2. Remove the pressure relief valve cap.
3. Measure and record the extension length of the adjusting screw to reset full bypass pressure during reassembly.
4. Loosen the pressure relief valve lock nut and then back out pressure relief valve bonnet and adjusting screw until the spring pressure is released.
5. Remove, clean and inspect all parts (i.e., bonnet, spring guide, spring and poppet) for wear or damage and replace as needed.

WET END ASSEMBLY:

1. Clean all parts thoroughly before assembly.
2. Install the RBS bushing. If the bushing has a lubrication groove, install the bushing with lubrication groove facing towards the bottom of the RBS. If applicable, align the radial lubrication hole on the bushing with a grease hole on the RBS.
3. For 55, 133 and 254 size pumps, attach the rear plate and gasket to the case.
4. Install the RBS gasket on the rear plate, aligning the holes with bolt pattern of the studs.
5. For 133, 254 and 423 size pumps, install the stationary thrust washer onto the RBS with the groove facing the rotor. Use a light coating of grease on the backside of the thrust washer to help retain it to the RBS during installation.
6. Attach the RBS assembly to the rear adapter plate/case.
7. Coat the rotor and shaft assembly with light oil.
8. Install rotating thrust washer on the rotor/shaft assembly and align with the driving pins. Use a light coating of grease on the backside of the thrust washer to help retain it to the rotor during installation.
9. Insert the end of the shaft through the case into the RBS bushing. Slowly push the rotor assembly until it touches the stationary thrust washer mounted on the RBS. (**CAUTION:** - Make sure the rotating thrust washer doesn't fall from the back of rotor during assembly.)
10. Press the idler pin into the head. Note the following during head assembly:
 - Idler pin cooling port should face the crescent while aligning the cross port with the appropriate porting in the head casting.
 - The idler pin must be recessed 0.010" – 0.030" below the face of the crescent (Refer to Figure B).
 - Install the NPT plug on the suction side of dovetail located on head casting. If applicable, install grease fitting or pipe plug on the idler pin.

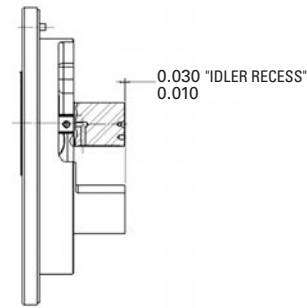

FIGURE B – IDLER PIN POSITION

11. Install the idler bushing.
12. Coat the idler pin with light oil.
13. Place the idler and bushing assembly on the idler pin.
14. Install the head gaskets onto the head, aligning the holes with the bolt pattern. Use the gasket set indicated in the "Starting Gasket Set" column from Table A.

Pump Models	Starting Gasket Set	Gasket Set Provided
V2-55	1 - .006" & 1 - .015"	2 - .006", 1 - .015"
V2-133, 254 & 423	1 - .006" & 1 - .015"	1 - .006", 2 - .015"

TABLE A – HEAD GASKET SETS

Pump Models	Clearance	Viscosity (cSt)	Temperature C (F)	Target Minimum End Play
All	A	< 1,600	<232°C (<450°F)	.005"
	B	1,600 – 16,000		.010"
	C	16,000 – 54,000		.015"

TABLE B – ROTOR END CLEARANCE/END PLAY

15. Install the head/idler assembly, using the dowel pin to determine proper alignment.
16. Measure the end play of the rotor/shaft assembly by placing a dial indicator at the end of the shaft. The dial indicator can also be placed through the PRV ports on the head allowing the indicator to contact the end of the rotor tooth. If end play is less than the "Target Minimum End Play" from Table B above, remove the head and use a different combination of gaskets. The supplied gasket set can be found in the "Gasket Set Provided" column from Table A.
17. If applicable, install pressure relief valve (see Section 4 for "PRESSURE RELIEF VALVE ASSEMBLY").
18. Install the mechanical seal or packing (see Section 5 for "MAINTENANCE").

V2-55

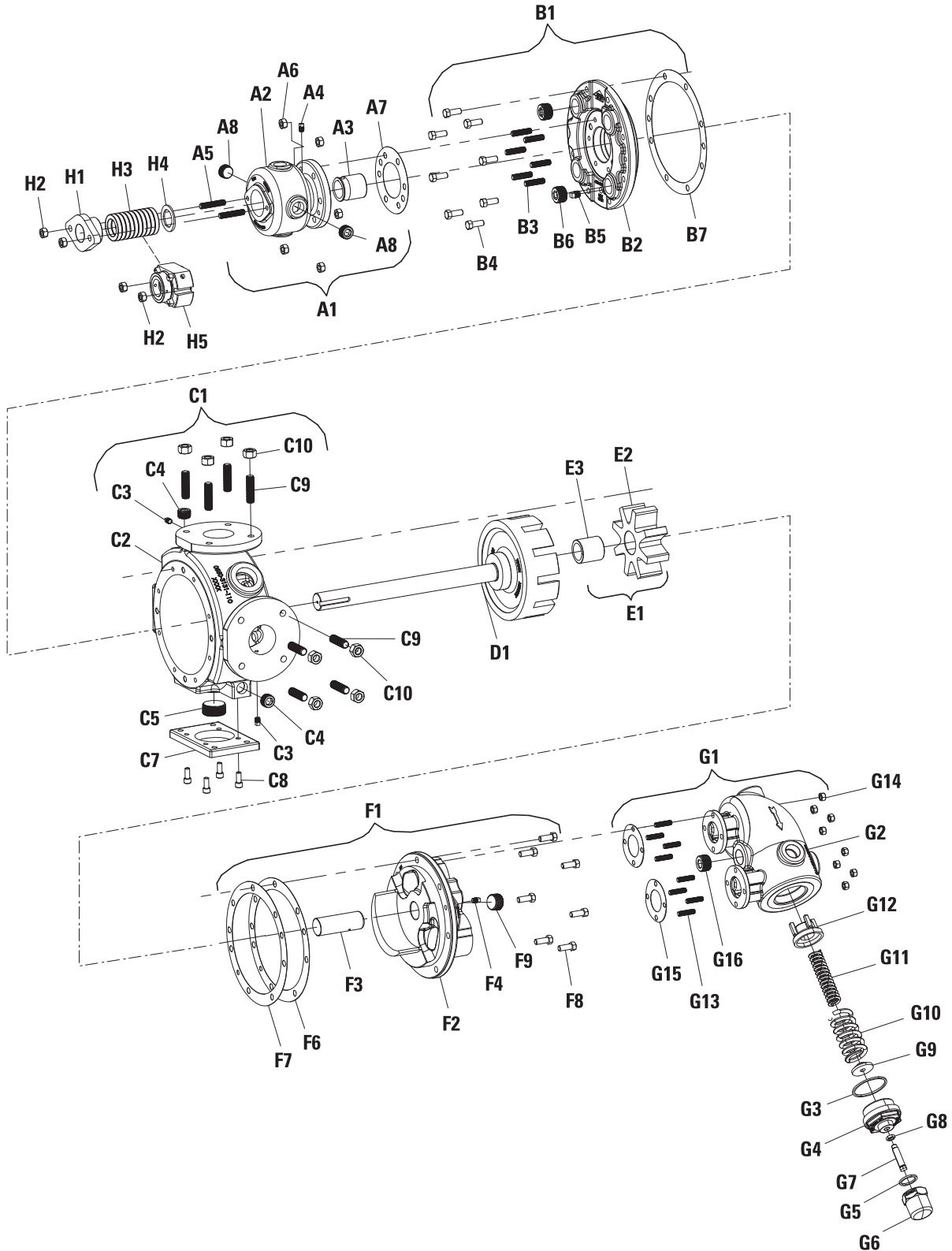

EXPLODED VIEW & PARTS LISTING



Item	Description	V2-55	Quantity	Material
A1	ROTOR BEARING SLEEVE, ASM, JACKETED, V-55, CAST IRON (INCLUDES A2 THRU A8)	0550-2040-110	1	CAST IRON
A2	ROTOR BEARING SLEEVE, JACKETED, V-55, CAST IRON	0550-2140-110	1	CAST IRON
A3	BUSHING, RBS, V-55, BRONZE	0550-2840-320	1	BRONZE
A4	PLUG, PIPE, 1/8" NPT, CARBON STEEL/ZINC PLATED	PLUG-013NSH-230	1	STEEL
A5	STUD, DOUBLE END, 7/16"-14 X 2-1/4", CARBON STEEL/ZINC PLATED	T09C438B25WA2A2	2	STEEL
A6	NUT, HEX, CENTERLOCK, 7/16"-14, CARBON STEEL/ZINC PLATED	N04C438375WA2A2	6	STEEL
A7	GASKET, RBS, V-55, INTERFACE TS-9003	0550-2930-950	1	INTERFACE TS-9003
A8	PLUG, PIPE, 3/4" NPT, CARBON STEEL/ZINC PLATED	PLUG-075NSH-230	2	STEEL
B1	REAR PLATE, ASM, JACKETED, V-55, CAST IRON (INCLUDES B2 THRU B7)	0550-3300-110	1	CAST IRON
B2	REAR PLATE, JACKETED, V-55, CAST IRON	0550-3330-110	1	CAST IRON
B3	STUD, DOUBLE END, 7-16"-14 X 1-3/4", CARBON STEEL/ZINC PLATED	T09C438A75WA2A2	6	STEEL
B4	SCREW, CAP, HEX, 7/16"-14 X 1-1/8", CARBON STEEL/ZINC PLATED	S01C438A12WA2A2	8	STEEL
B5	PLUG, PIPE, 1/4" NPT, CARBON STEEL/ZINC PLATED	PLUG-025NSH-230	1	STEEL
B6	PLUG, PIPE, 1" NPT, CARBON STEEL/ZINC PLATED	PLUG-100NSH-230	2	STEEL
B7	GASKET, BRACKET/REAR PLATE, G1-55/69, V-55 INTERFACE TS-9003	0550-2900-950	1	INTERFACE TS-9003
C1	CASE, ASM, JACKETED, V-55, 2.5" ANSI, CAST IRON (INCLUDES C2 THRU C10)	0550-3031-110	1	CAST IRON
C2	CASE, JACKETED, G/V-55, 2.5" ANSI, CAST IRON	0550-3131-110	1	CAST IRON
C3	PLUG, PIPE, 1/8" NPT, CARBON STEEL/ZINC PLATED	PLUG-013NSH-230	2	STEEL
C4	PLUG, PIPE, 3/4" NPT, CARBON STEEL/ZINC PLATED	PLUG-075NSH-230	2	STEEL
C5	PLUG, PIPE, 1-1/2" NPT, CARBON STEEL/ZINC PLATED	PLUG-150NSH-230	1	STEEL
C7	FOOT, CASE, V-55, CARBON STEEL	0550-3400-230	1	STEEL
C8	SCREW, CAP, HEX SOCKET HEAD, 3/8"-16 X 3/4", CARBON STEEL/ZINC PLATED	S14C37570VA2A2	4	STEEL
C9	STUD, DOUBLE END, 5/8"-11 X 2-1/4", CARBON STEEL/ZINC PLATED	T09C625B25WA2A2	8	STEEL
C10	NUT, HEX, 5/8"-11, CARBON STEEL/ZINC PLATED	N04C625562WA2A2	8	STEEL
D1	ROTOR/SHAFT, ASM, V-55, A, DUCTILE IRON/CARBON STEEL	0550-4040-121	1	DUCTILE IRON/STEEL
	ROTOR/SHAFT, ASM, V-55, B, DUCTILE IRON/CARBON STEEL	0550-4041-121	1	DUCTILE IRON/STEEL
	ROTOR/SHAFT, ASM, V-55, C, DUCTILE IRON/CARBON STEEL	0550-4042-121	1	DUCTILE IRON/STEEL
E1	GEAR, IDLER, ASM, G/V-55, CAST IRON/BRONZE (INCLUDES E2 AND E3)	0550-5010-110	1	CAST IRON/BRONZE
E2	GEAR, IDLER, G/V-55, CAST IRON	0550-5100-110	1	CAST IRON
E3	BUSHING, IDLER, G/V-55, BRONZE	0550-5800-320	1	BRONZE
F1	HEAD, ASM, G/V-55, CAST IRON/HARDENED STEEL (INCLUDES F2 THRU F7)	0550-6010-110	1	CAST IRON/STEEL
	HEAD, ASM, JACKETED, G/V-55, CAST IRON/HARDENED STEEL	0550-6030-110	1	CAST IRON/STEEL
F2	HEAD, G/V-55, CAST IRON	0550-6110-110	1	CAST IRON
	HEAD, JACKETED, G/V-55, CAST IRON	0550-6130-110	1	CAST IRON
F3	PIN, IDLER, G/V-55, HARDENED STEEL	0550-6200-231	1	HARDENED STEEL
F4	PLUG, PIPE, 1/8" NPT, CARBON STEEL/ZINC PLATED	PLUG-013NSH-230	1	STEEL
F6	GASKET, HEAD, G1-55/69/82, V-55, BRACKET, G1-82, .015, INTERFACE TS-9003	0550-6900-950	1	INTERFACE TS-9003
F7	GASKET, HEAD, V-55, .005, HI TEMP GRAPHITE	0550-6901-952	2	GRAPHITE 2010B
F9	PLUG, PIPE, 1" NPT, CARBON STEEL/ZINC PLATED	PLUG-100NSH-230	1	STEEL
F8	SCREW, CAP, HEX, 7/16"-14 X 1-1/8", CARBON STEEL/ZINC PLATED	S01C438A12WA2A2	7	STEEL
G1	VALVE, COVER, ASM, G1-55/69/82, V-55, STAINLESS STEEL/CARBON STEEL (INCLUDES G2, G13 THRU G15)	0550-7000-230	1	STEEL/STAINLESS STEEL
	VALVE, ASM, G1-55/69/82, V-55, 60 PSI, CAST IRON (INCLUDES G2 THRU G16)	0550-7001-110	1	CAST IRON
	VALVE, ASM, G1-55/69/82, V-55, 90 PSI, CAST IRON (INCLUDES G2 THRU G16)	0550-7002-110	1	CAST IRON
	VALVE, ASM, G1-55/69/82, V-55, 160 PSI, CAST IRON (INCLUDES G2 THRU G16)	0550-7003-110	1	CAST IRON
	VALVE, ASM, JACKETED, G1-55/69/82, V-55, 60 PSI, CAST IRON (INCLUDES G2 THRU G16)	0550-7031-110	1	CAST IRON
	VALVE, ASM, JACKETED, G1-55/69/82, V-55, 90 PSI, CAST IRON (INCLUDES G2 THRU G16)	0550-7032-110	1	CAST IRON
	VALVE, ASM, JACKETED, G1-55/69/82, V-55, 160 PSI, CAST IRON (INCLUDES G2 THRU G16)	0550-7033-110	1	CAST IRON
G2	VALVE, BODY, G1-55/69/82, V-55, CAST IRON	0550-7100-110	1	CAST IRON
	VALVE, BODY, JACKETED, G1-55/69/82, V-55, CAST IRON	0550-7130-110	1	CAST IRON
	VALVE, COVER, G1-55/69/82, V-55, STAINLESS STEEL	0550-7101-250	2	STEEL/STAINLESS STEEL
G3	GASKET, VALVE, BONNET, G1-24/32/55/69/82, V-55, KLINGERSIL C-4401	0240-7910-951	1	KLINGERSIL C-4401
G4	VALVE, BONNET, G1-24/32/55/69/82, V-55, CAST IRON	0240-7200-110	1	CAST IRON
G5	GASKET, VALVE, CAP, G1-24/32/55/69/82, V-55, KLINGERSIL C-4401	0240-7920-951	1	KLINGERSIL C-4401
G6	VALVE, CAP, G1-24/32/55/69/82, V-55, CAST IRON	0240-7300-110	1	CAST IRON
G7	VALVE, ADJ SCREW, G1-24/32/55/69/82, V-55, CARBON STEEL	0240-7700-230	1	STEEL
G8	VALVE, LOCK NUT, G1-24/32/55/69/82, V-55, CARBON STEEL	0240-7710-230	1	STEEL
G9	VALVE, SPRING GUIDE, G1-24/32/55/69/82, V-55, CARBON STEEL	0240-7500-230	1	STEEL
G10	VALVE, SPRING, G1-24/32 (150/200 PSI), G1-55/69/82, V-55 (90/150/160/200 PSI)	0240-7602-250	1	STAINLESS STEEL
G11	VALVE, SPRING, G1-24/32 (50 PSI), G1-55/69/82, V-55 (60 PSI)	0240-7600-250	1	STAINLESS STEEL
	VALVE, SPRING, G1-24/32 (80/200 PSI), G1-55/69/82, V-55 (90/200 PSI)	0240-7601-250	1	STAINLESS STEEL
G12	VALVE, POPPET, G1-24/32/55/69/82, V-55, CAST IRON	0240-7400-110	1	CAST IRON
G13	STUD, DOUBLE END, 3/8"-16 X 1-1/2", CARBON STEEL/ZINC PLATED	T09C375A50VA2A2	8	STEEL
G14	NUT, HEX, 3/8"-16, CARBON STEEL/ZINC PLATED	N04C375375WA2A2	8	STEEL
G15	GASKET, VALVE, G1-55/69/82, V-55, INTERFACE TS-9003	0550-7900-950	2	INTERFACE TS-9003
G16	PLUG, PIPE, 3/4" NPT, CARBON STEEL/ZINC PLATED	PLUG-075NSH-230	3	STEEL
H1	GLAND, PACKING, V-55, CAST IRON	0550-8230-110	1	CAST IRON
H2	NUT, HEX, CENTERLOCK, 7/16"-14, CARBON STEEL/ZINC PLATED	N04C438375WA2A2	2	STEEL
H3	PACKING, ASM, V-55, 10 RINGS, PTFE-GRAPHITE	0550-8100-925K	1	PTFE-GRAPHITE
	PACKING, ASM, V-55, 10 RINGS, WEDGE PTFE-GRAPHITE	0550-8102-932	1	VARIOUS
H4	WASHER, PACKING RETAINING, V-55, CARBON STEEL	0550-8150-230	1	STEEL
H5	SEAL, TRIPLE LIP SEAL, V-55, SIL CARBIDE/CHEMRAZ/PTFE	0550-8002-929	1	TEFLON/SIC/CHEMRAZ
	SEAL, TRIPLE LIP SEAL, V-55, SIL CARBIDE/AFLAS/PTFE	0550-8002-933	1	TEFLON/SIC/AFLAS

V2-133

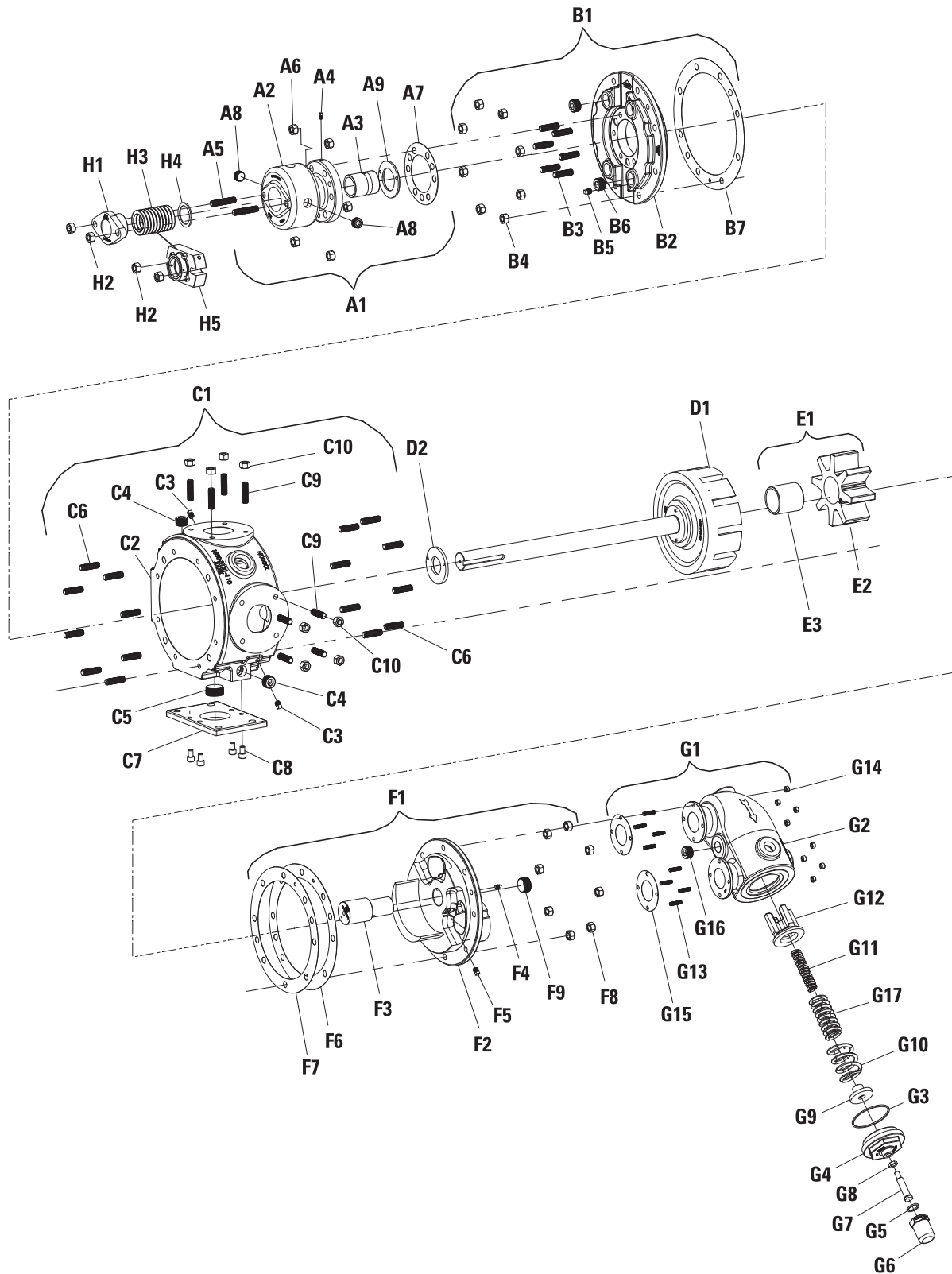

EXPLODED VIEW & PARTS LISTING



Item	Description	V2-133	Quantity	Material
A1	ROTOR BEARING SLEEVE, ASM, JACKETED, V-133/254, CAST IRON (INCLUDES A2 THRU A9)	1330-2040-110	1	CAST IRON
A2	ROTOR BEARING SLEEVE, JACKETED, V-133/254, CAST IRON	1330-2140-110	1	CAST IRON
A3	BUSHING, RBS, V-133/254, BRONZE	1330-2840-320	1	BRONZE
A4	PLUG, PIPE, 1/8" NPT, CARBON STEEL/ZINC PLATED	PLUG-013NSH-230	1	STEEL
A5	STUD, DOUBLE END, 5/8"-11 X 3", CARBON STEEL/ZINC PLATED	T09C625C00WA2A2	2	STEEL
A6	NUT, HEX, 5/8"-11, CARBON STEEL/ZINC PLATED	N04C625562WA2A2	6	STEEL
A7	GASKET, RBS, V-133/254, INTERFACE TS-9003	1330-2930-950	1	INTERFACE TS-9003
A8	PLUG, PIPE, 3/4" NPT, CARBON STEEL/ZINC PLATED	PLUG-075NSH-230	2	STEEL
A9	BUSHING, STATIONARY THRUST, V-133/254, BRONZE	1330-4831-320	1	BRONZE
B1	REAR PLATE, ASM, JACKETED, V-133, CAST IRON (INCLUDES B2 THRU B7)	1330-3300-110	1	CAST IRON
B2	REAR PLATE, JACKETED, V-133, CAST IRON	1330-3330-110	1	CAST IRON
B3	STUD, DOUBLE END, 5/8"-11 X 2-1/4", CARBON STEEL/ZINC PLATED	T09C625B25WA2A2	6	STEEL
B4	NUT, HEX, 5/8"-11, CARBON STEEL/ZINC PLATED	N04C625562WA2A2	8	STEEL
B5	PLUG, PIPE, 1/4" NPT, CARBON STEEL/ZINC PLATED	PLUG-025NSH-230	1	STEEL
B6	PLUG, PIPE, 1" NPT, CARBON STEEL/ZINC PLATED	PLUG-100NSH-230	2	STEEL
B7	GASKET, BRACKET/HEAD, G1-133/222, V-133, .015, INTERFACE TS-9003	1330-6900-950	1	INTERFACE TS-9003
C1	CASE, ASM, JACKETED, V-133, 3" ANSI, CAST IRON (INCLUDES C2 THRU C10)	1330-3031-110	1	CAST IRON
C2	CASE, JACKETED, G/V-133, 3" ANSI, CAST IRON	1330-3131-110	1	CAST IRON
C3	PLUG, PIPE, 1/4" NPT, CARBON STEEL/ZINC PLATED	PLUG-025NSH-230	2	STEEL
C4	PLUG, PIPE, 1" NPT, CARBON STEEL/ZINC PLATED	PLUG-100NSH-230	2	STEEL
C5	PLUG, PIPE, 1-1/2" NPT, CARBON STEEL/ZINC PLATED	PLUG-150NSH-230	1	STEEL
C6	STUD, DOUBLE END, 5/8"-11 X 2-1/4", CARBON STEEL/ZINC PLATED	T09C625B25WA2A2	8	STEEL
C7	STUD, DOUBLE END, 5/8"-11 X 2-1/4", CARBON STEEL/ZINC PLATED	T09C625B25WA2A2	8	STEEL
C8	FOOT, CASE, V-133, CARBON STEEL	1330-3400-230	1	STEEL
C9	SCREW, CAP, HEX SOCKET HEAD, 1/2"-13 X 1/2", CARBON STEEL/ZINC PLATED	S14C500500WA2A2	4	STEEL
C10	STUD, DOUBLE END, 5/8"-11 X 2-3/4", CARBON STEEL/ZINC PLATED	T09C625B75WA2A2	8	STEEL
D1	NUT, HEX, 5/8"-11, CARBON STEEL/ZINC PLATED	N04C625562WA2A2	8	STEEL
D1	ROTOR/SHAFT, ASM, V-133, A, DUCTILE IRON/CARBON STEEL	1330-4040-121	1	DUCTILE IRON/STEEL
D1	ROTOR/SHAFT, ASM, V-133, B, DUCTILE IRON/CARBON STEEL	1330-4041-121	1	DUCTILE IRON/STEEL
D1	ROTOR/SHAFT, ASM, V-133, C, DUCTILE IRON/CARBON STEEL	1330-4042-121	1	DUCTILE IRON/STEEL
D2	BUSHING, ROTATING THRUST, V-133/254, HARDENED STEEL	1330-4830-370	1	HARDENED ALLOY STEEL
E1	GEAR, IDLER, ASM, G/V-133, DUCTILE IRON/BRONZE	1330-5010-121	1	DUCTILE/BRONZE
E2	GEAR, IDLER, G/V-133, DUCTILE IRON	1330-5100-121	1	DUCTILE
E3	BUSHING, IDLER, G/V-133/254, BRONZE	1330-5800-320	1	BRONZE
F1	HEAD, ASM, G/V-133, CAST IRON/HARDENED STEEL (INCLUDES F2 THRU F8)	1330-6010-110	1	CAST IRON/STEEL
F1	HEAD, ASM, JACKETED, G/V-133, CAST IRON/HARDENED STEEL	1330-6030-110	1	CAST IRON/STEEL
F2	HEAD, G/V-133, CAST IRON	1330-6110-110	1	CAST IRON
F2	HEAD, JACKETED, G/V-133, CAST IRON	1330-6130-110	1	CAST IRON
F3	PIN, IDLER, G/V-133/254, HARDENED STEEL	1330-6200-231	1	HARDENED STEEL
F4	PLUG, PIPE, 1/8" NPT, CARBON STEEL/ZINC PLATED	PLUG-013NSH-230	1	STEEL
F5	PLUG, PIPE, 1/4" NPT, CARBON STEEL/ZINC PLATED	PLUG-025NSH-230	1	STEEL
F6	GASKET, BRACKET/HEAD, G1-133/222, V-133, .015, INTERFACE TS-9003	1330-6900-950	2	INTERFACE TS-9003
F7	GASKET, BRACKET, G1-133/222, V-133, .005, HI TEMP GRAPHITE	1330-6901-952	1	GRAPHITE 2010B
F8	NUT, HEX, 5/8"-11, CARBON STEEL/ZINC PLATED	N04C625562WA2A2	8	STEEL
F9	PLUG, PIPE, 1-1/4" NPT, CARBON STEEL/ZINC PLATED	PLUG-125NSH-230	1	STEEL
G1	VALVE, COVER, ASM, G1-133/222, V-133, STAINLESS STEEL/CARBON STEEL (INCLUDES G2, G13 THRU G15)	1330-7000-230	1	STAINLESS STEEL/STEEL
G1	VALVE, ASM, G1-133/222, V-133, 50 PSI, CAST IRON (INCLUDES G2 THRU G9, G11 THRU G16)	1330-7001-110	1	CAST IRON
G1	VALVE, ASM, G1-133/222, V-133, 80 PSI, CAST IRON (INCLUDES G2 THRU G9, G12 THRU G17)	1330-7002-110	1	CAST IRON
G1	VALVE, ASM, G1-133/222, V-133, 130 PSI, CAST IRON (INCLUDES G2 THRU G9, G11 THRU G17)	1330-7003-110	1	CAST IRON
G1	VALVE, ASM, JACKETED, G1-133/222, V-133, 50 PSI, CAST IRON (INCLUDES G2 THRU G9, G11 THRU G16)	1330-7031-110	1	CAST IRON
G1	VALVE, ASM, JACKETED, G1-133/222, V-133, 80 PSI, CAST IRON (INCLUDES G2 THRU G9, G12 THRU 17)	1330-7032-110	1	CAST IRON
G1	VALVE, ASM, JACKETED, G1-133/222, V-133, 130 PSI, CAST IRON (INCLUDES G2 THRU G9, G11 THRU G17)	1330-7033-110	1	CAST IRON
G2	VALVE, BODY, G1-133/222, V-133, CAST IRON	1330-7100-110	1	CAST IRON
G2	VALVE, BODY, JACKETED, G1-133/222, V-133, CAST IRON	1330-7130-110	1	CAST IRON
G2	VALVE, COVER, G1-133/222, V-133, STAINLESS STEEL	1330-7101-250	2	STAINLESS STEEL/STEEL
G3	GASKET, VALVE, BONNET, G1-133/222, V-133/254/423, KLINGERSIL C-4401	1330-7910-951	1	KLINGERSIL C-4401
G4	VALVE, BONNET, G1-133/222, V-133/254/423, CAST IRON	1330-7200-110	1	CAST IRON
G5	GASKET, VALVE, CAP, G1-133/222, V-133/254/423, KLINGERSIL C-4401	1330-7920-951	1	KLINGERSIL C-4401
G6	VALVE, CAP, G1-133/222, V-133/254/423, CAST IRON	1330-7300-110	1	CAST IRON
G7	VALVE, ADJ SCREW, G1-133/222, V-133/254/423, STAINLESS STEEL	1330-7700-255	1	STAINLESS STEEL
G8	VALVE, LOCK NUT, G1-133/222, V-133/254/423, STAINLESS STEEL	1330-7710-255	1	STAINLESS STEEL
G9	VALVE, SPRING GUIDE, G1-133/222, V-133/254/423, STAINLESS STEEL	1330-7500-250	1	STAINLESS STEEL
G10	VALVE, SPRING, G1-133/222, V-133 (150/200 PSI)	1330-7602-250	1	STAINLESS STEEL
G11	VALVE, SPRING, G1-133/222 (50/130/150/200 PSI), V-133 (50/130/200 PSI), V-254 (60/140 PSI), V-423 (70 PSI)	1330-7600-250	1	STAINLESS STEEL
G12	VALVE, POPPET, G1-133/222, V-133/254/423, CAST IRON	1330-7400-110	1	CAST IRON
G13	STUD, DOUBLE END, 3/8"-16 X 1-1/2", CARBON STEEL/ZINC PLATED	T09C375A50WA2A2	8	STEEL
G14	NUT, HEX, 3/8"-16, CARBON STEEL/ZINC PLATED	N04C375375WA2A2	8	STEEL
G15	GASKET, VALVE, G1-133/222, V-133, INTERFACE TS-9003	1330-7900-950	2	INTERFACE TS-9003
G16	PLUG, PIPE, 3/4" NPT, CARBON STEEL/ZINC PLATED	PLUG-075NSH-230	3	STEEL
G17	VALVE, SPRING, G1-133/222 (80/130/150/200 PSI), V-133 (80/130/200 PSI), V-254 (100/140 PSI), V-423 (125 PSI)	1330-7601-250	1	STAINLESS STEEL
H1	GLAND, PACKING, V-133/254, CAST IRON	2540-8230-110	1	CAST IRON
H2	NUT, HEX, 5/8"-11, CARBON STEEL/ZINC PLATED	N04C625562WA2A2	2	STEEL
H3	PACKING, ASM, V-133/254, 10 RINGS, PTFE-GRAPHITE	2540-8100-925K	10	PTFE-GRAPHITE
H3	PACKING, ASM, V-133/254, 10 RINGS, WEDGEE PTFE-GRAPHITE	2540-8102-932	10	VARIOUS
H4	WASHER, PACKING RETAINING, V-133/254, CARBON STEEL	2540-8150-230	1	STEEL
H5	SEAL, TRIPLE LIP SEAL, V-133/254, SIL CARBIDE/CHEMRAZ/PTFE	1330-8002-929	1	TEFLON/SIC/CHEMRAZ
H5	SEAL, TRIPLE LIP SEAL, V-133/254, SIL CARBIDE/AFLAS/PTFE	1330-8002-933	1	TEFLON/SIC/AFLAS

V2-254

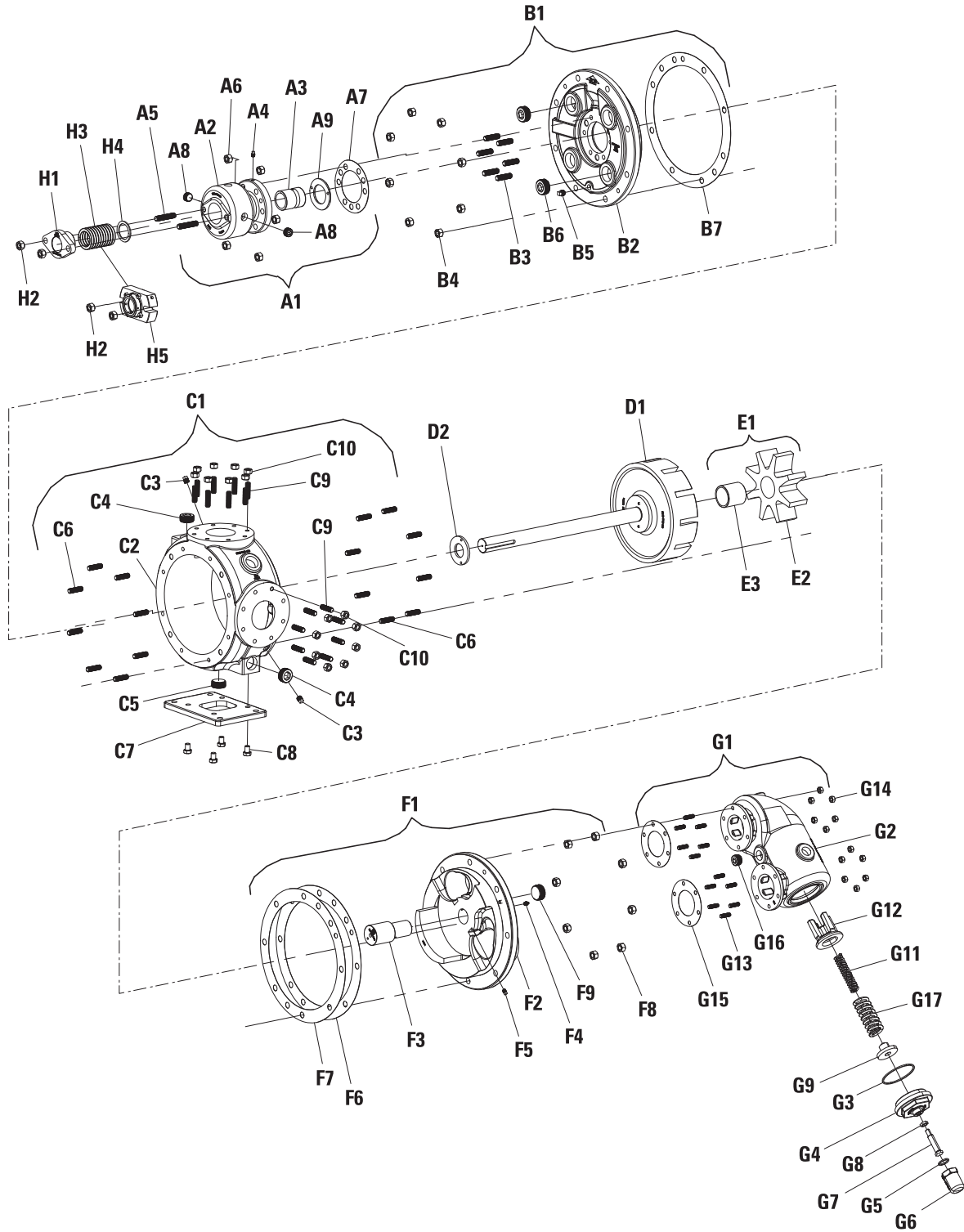

EXPLODED VIEW & PARTS LISTING



Item	Description	V2-254	Quantity	Material
A1	ROTOR BEARING SLEEVE, ASM, JACKETED, V-133/254, CAST IRON (INCLUDES A2 THRU A9)	1330-2040-110	1	CAST IRON
A2	ROTOR BEARING SLEEVE, JACKETED, V-133/254, CAST IRON	1330-2140-110	1	CAST IRON
A3	BUSHING, RBS, V-133/254, BRONZE	1330-2840-320	1	BRONZE
A4	PLUG, PIPE, 1/8" NPT, CARBON STEEL/ZINC PLATED	PLUG-013NSH-230	1	STEEL
A5	STUD, DOUBLE END, 5/8"-11 X 3", CARBON STEEL/ZINC PLATED	T09C625C00WA2A2	2	STEEL
A6	NUT, HEX, 5/8"-11, CARBON STEEL/ZINC PLATED	N04C625562WA2A2	6	STEEL
A7	GASKET, RBS, V-133/254, INTERFACE TS-9003	1330-2930-950	1	INTERFACE TS-9003
A8	PLUG, PIPE, 3/4" NPT, CARBON STEEL/ZINC PLATED	PLUG-075NSH-230	2	STEEL
A9	BUSHING, STATIONARY THRUST, V-133/254, BRONZE	1330-4831-320	1	BRONZE
B1	REAR PLATE, ASM, JACKETED, V-254, CAST IRON (INCLUDES B2 THRU B7)	2540-3300-110	1	CAST IRON
B2	REAR PLATE, JACKETED, V-254, CAST IRON	2540-3330-110	1	CAST IRON
B3	STUD, DOUBLE END, 5/8"-11 X 2-1/4", CARBON STEEL/ZINC PLATED	T09C625B25WA2A2	6	STEEL
B4	NUT, HEX, 5/8"-11, CARBON STEEL/ZINC PLATED	N04C625562WA2A2	8	STEEL
B5	PLUG, PIPE, 3/8" NPT, CARBON STEEL/ZINC PLATED	PLUG-038NSH-230	1	STEEL
B6	PLUG, PIPE, 1-1/2" NPT, CARBON STEEL/ZINC PLATED	PLUG-150NSH-230	2	STEEL
B7	GASKET, BRACKET/HEAD, V-254/423, .015, INTERFACE TS-9003	2540-6900-950	1	INTERFACE TS-9003
C1	CASE, ASM, JACKETED, V-254, 4" ANSI, CAST IRON (INCLUDES C2 THRU C10)	2540-3031-110	1	CAST IRON
C2	CASE, JACKETED, G/V-254, 4" ANSI, CAST IRON	2540-3131-110	1	CAST IRON
C3	PLUG, PIPE, 3/8" NPT, CARBON STEEL/ZINC PLATED	PLUG-038NSH-230	2	STEEL
C4	PLUG, PIPE, 1-1/2" NPT, CARBON STEEL/ZINC PLATED	PLUG-150NSH-230	2	STEEL
C5	PLUG, PIPE, 1-1/2" NPT, CARBON STEEL/ZINC PLATED	PLUG-150NSH-230	1	STEEL
C6	STUD, DOUBLE END, 5/8"-11 X 2-1/2", CARBON STEEL/ZINC PLATED	T09C625B50WA2A2	8	STEEL
	STUD, DOUBLE END, 5/8"-11 X 2-1/2", CARBON STEEL/ZINC PLATED	T09C625B50WA2A2	8	STEEL
C7	FOOT, CASE, V-254/423, CARBON STEEL	2540-3400-230	1	STEEL
C8	SCREW, CAP, HEX, 5/8"-11 X 3/4", CARBON STEEL/ZINC PLATED	S01C625750WA2A4	4	STEEL
C9	STUD, DOUBLE END, 5/8"-11 X 2-3/4", CARBON STEEL/ZINC PLATED	T09C625B75WA2A2	16	STEEL
C10	NUT, HEX, 5/8"-11, CARBON STEEL/ZINC PLATED	N04C625562WA2A2	16	STEEL
D1	ROTOR/SHAFT, ASM, V-254, A, DUCTILE IRON/CARBON STEEL	2540-4040-121	1	DUCTILE IRON/STEEL
	ROTOR/SHAFT, ASM, V-254, B, DUCTILE IRON/CARBON STEEL	2540-4041-121	1	DUCTILE IRON/STEEL
	ROTOR/SHAFT, ASM, V-254, C, DUCTILE IRON/CARBON STEEL	2540-4042-121	1	DUCTILE IRON/STEEL
D2	BUSHING, ROTATING THRUST, V-133/254, HARDENED STEEL	1330-4830-370	1	HARDENED ALLOY STEEL
E1	GEAR, IDLER, ASM, G/V-254, DUCTILE IRON/BRONZE	2540-5010-121	1	DUCTILE/BRONZE
E2	GEAR, IDLER, G/V-254, DUCTILE IRON	2540-5100-121	1	DUCTILE
E3	BUSHING, IDLER, G/V-133/254, BRONZE	1330-5800-320	1	BRONZE
F1	HEAD, ASM, G/V-254, CAST IRON/HARDENED STEEL (INCLUDES F2 THRU F8)	2540-6010-110	1	CAST IRON/STEEL
	HEAD, ASM, JACKETED, G/V-254, CAST IRON/HARDENED STEEL	2540-6030-110	1	CAST IRON/STEEL
F2	HEAD, G/V-254, CAST IRON	2540-6110-110	1	CAST IRON
	HEAD, JACKETED, G/V-254, CAST IRON	2540-6130-110	1	CAST IRON
F3	PIN, IDLER, G/V-133/254, HARDENED STEEL	1330-6200-231	1	HARDENED STEEL
F4	PLUG, PIPE, 1/8" NPT, CARBON STEEL/ZINC PLATED	PLUG-013NSH-230	1	STEEL
F5	PLUG, PIPE, 1/8" NPT, CARBON STEEL/ZINC PLATED	PLUG-013NSH-230	1	STEEL
F6	GASKET, BRACKET/HEAD, V-254/423, .015, INTERFACE TS-9003	2540-6900-950	2	INTERFACE TS-9003
F7	GASKET, HEAD, V-254/423, .005, HI TEMP GRAPHITE	2540-6901-952	1	GRAPHITE 2010B
F8	NUT, HEX, 5/8"-11, CARBON STEEL/ZINC PLATED	N04C625562WA2A2	8	STEEL
F9	PLUG, PIPE, 1-1/2" NPT, CARBON STEEL/ZINC PLATED	PLUG-150NSH-230	1	STEEL
G1	VALVE, COVER ASM, V-254/423, STAINLESS STEEL/CARBON STEEL (INCLUDES G2, G13 THRU G15)	2540-7000-230	1	STEEL
	VALVE, ASM, V-254/423, 60/70 PSI, CAST IRON (INCLUDES G2 THRU G16)	2540-7001-110	1	CAST IRON
	VALVE, ASM, V-254/423, 100/125 PSI, CAST IRON (INCLUDES G2 THRU G9 and G12 THRU 17)	2540-7002-110	1	CAST IRON
	VALVE, ASM, V-254, 140 PSI, CAST IRON (INCLUDES G2 THRU G17)	2540-7003-110	1	CAST IRON
	VALVE, ASM, JACKETED, V-254/423, 60/70 PSI, CAST IRON (INCLUDES G2 THRU G16)	2540-7031-110	1	CAST IRON
	VALVE, ASM, JACKETED, V-254/423, 100/125 PSI, CAST IRON (INCLUDES G2 THRU G9 and G12 THRU 17)	2540-7032-110	1	CAST IRON
	VALVE, ASM, JACKETED, V-254, 140 PSI, CAST IRON (INCLUDES G2 THRU G17)	2540-7033-110	1	CAST IRON
G2	VALVE, BODY, V-254/423, CAST IRON	2540-7100-110	1	CAST IRON
	VALVE, BODY, JACKETED, V-254/423, CAST IRON	2540-7130-110	1	CAST IRON
	VALVE, COVER, V-254/423, CARBON STEEL	2540-7101-230	2	STEEL
G3	GASKET, VALVE, BONNET, G1-133/222, V-133/254/423, KLINGERSIL C-4401	1330-7910-951	1	KLINGERSIL C-4401
G4	VALVE, BONNET, G1-133/222, V-133/254/423, CAST IRON	1330-7200-110	1	CAST IRON
G5	GASKET, VALVE, CAP, G1-133/222, V-133/254/423, KLINGERSIL C-4401	1330-7920-951	1	KLINGERSIL C-4401
G6	VALVE, CAP, G1-133/222, V-133/254/423, CAST IRON	1330-7300-110	1	CAST IRON
G7	VALVE, ADJ SCREW, G1-133/222, V-133/254/423, STAINLESS STEEL	1330-7700-255	1	STAINLESS STEEL
G8	VALVE, LOCK NUT, G1-133/222, V-133/254/423, STAINLESS STEEL	1330-7710-255	1	STAINLESS STEEL
G9	VALVE, SPRING GUIDE, G1-133/222, V-133/254/423, STAINLESS STEEL	1330-7500-250	1	STAINLESS STEEL
G11	VALVE, SPRING, G1-133/222 (50/130/150/200 PSI), V-133 (50/130/200 PSI), V-254 (60/140 PSI), V-423 (70 PSI)	1330-7600-250	1	STAINLESS STEEL
G12	VALVE, POPPET, G1-133/222, V-133/254/423, CAST IRON	1330-7400-110	1	CAST IRON
G13	STUD, DOUBLE END, 7/16"-14 X 1-1/2", CARBON STEEL/ZINC PLATED	T09C438A50WA2A2	12	STEEL
G14	NUT, HEX, CENTERLOCK, 7/16"-14, CARBON STEEL/ZINC PLATED	N04C438375WA2A2	12	STEEL
G15	GASKET, VALVE, V-254/423, INTERFACE TS-9003	2540-7900-950	2	INTERFACE TS-9003
G16	PLUG, PIPE, 3/4" NPT, CARBON STEEL/ZINC PLATED	PLUG-075NSH-230	3	STEEL
G17	VALVE, SPRING, G1-133/222 (80/130/150/200), V-133 (80/130/200 PSI), V-254 (100/140 PSI), V-423 (125 PSI)	1330-7601-250	1	STAINLESS STEEL
H1	GLAND, PACKING, V-133/254, CAST IRON	2540-8230-110	1	CAST IRON
H2	NUT, HEX, 5/8"-11, CARBON STEEL/ZINC PLATED	N04C625562WA2A2	2	STEEL
H3	PACKING, ASM, V-133/254, 10 RINGS, PTFE-GRAPHITE	2540-8100-925K	10	PTFE-GRAPHITE
	PACKING, ASM, V-133/254, 10 RINGS, WEDGEE PTFE-GRAPHITE	2540-8102-932	10	VARIOUS
H4	WASHER, PACKING RETAINING, V-133/254, CARBON STEEL	2540-8150-230	1	STEEL
H5	SEAL, TRIPLE LIP SEAL, V-133/254, SIL CARBIDE/CHEMRAZ/PTFE	1330-8002-929	1	TEFLON/SIC/CHEMRAZ
	SEAL, TRIPLE LIP SEAL, V-133/254, SIL CARBIDE/AFLAS/PTFE	1330-8002-933	1	TEFLON/SIC/AFLAS

V2-423

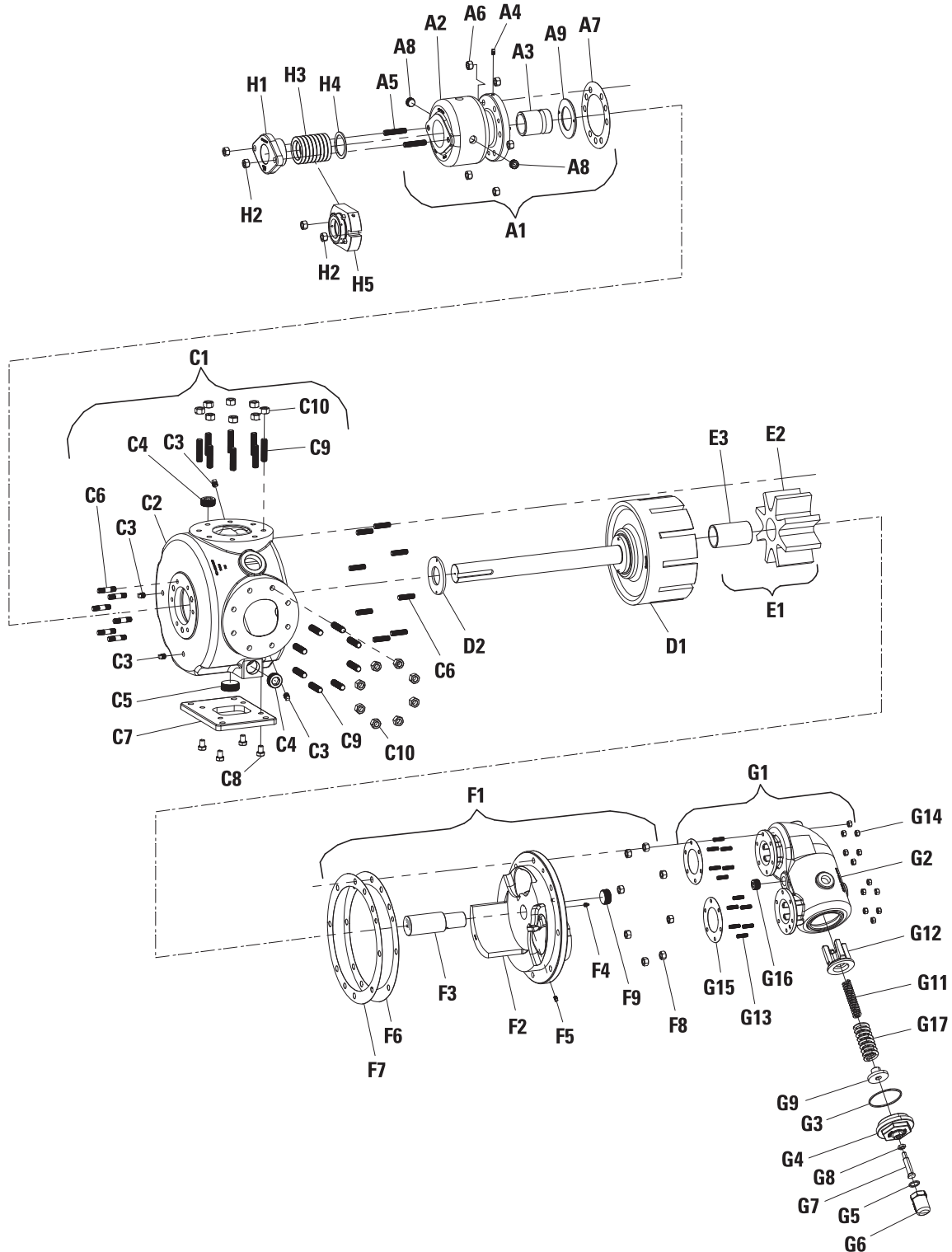

EXPLODED VIEW & PARTS LISTING



Item	Description	V2-423	Quantity	Material
A1	ROTOR BEARING SLEEVE, ASM, JACKETED, V-423, CAST IRON (INCLUDES A2 THRU A9)	4230-2040-110	1	CAST IRON
A2	ROTOR BEARING SLEEVE, JACKETED, V-423, CAST IRON	4230-2140-110	1	CAST IRON
A3	BUSHING, RBS, V-423, BRONZE	4230-2840-320	1	BRONZE
A4	PLUG, PIPE, 1/8" NPT, CARBON STEEL/ZINC PLATED	PLUG-013NSH-230	1	STEEL
A5	STUD, DOUBLE END, 5/8"-11 X 3", CARBON STEEL/ZINC PLATED	T09C625C00WA2A2	2	STEEL
A6	NUT, HEX, 5/8"-11, CARBON STEEL/ZINC PLATED	N04C625562WA2A2	6	STEEL
A7	GASKET, RBS, V-423, INTERFACE TS-9003	4230-2930-950	1	INTERFACE TS-9003
A8	PLUG, PIPE, 3/4" NPT, CARBON STEEL/ZINC PLATED	PLUG-075NSH-230	2	STEEL
A9	BUSHING, STATIONARY THRUST, V-423, BRONZE	4230-4831-320	1	BRONZE
C1	CASE, ASM, JACKETED, V-423, 5" ANSI, CAST IRON (INCLUDES C2 THRU C10)	4230-3031-110	1	CAST IRON
C2	CASE, JACKETED, G/V-423, 5" ANSI, CAST IRON	4230-3131-110	1	CAST IRON
C3	PLUG, PIPE, 3/8" NPT, CARBON STEEL/ZINC PLATED	PLUG-038NSH-230	4	STEEL
C4	PLUG, PIPE, 1-1/2" NPT, CARBON STEEL/ZINC PLATED	PLUG-150NSH-230	2	STEEL
C5	PLUG, PIPE, 2" NPT, CARBON STEEL/ZINC PLATED	PLUG-200NSH-230	1	STEEL
C6	STUD, DOUBLE END, 5/8"-11 X 2-1/2", CARBON STEEL/ZINC PLATED	T09C625B50WA2A2	6	STEEL
C6	STUD, DOUBLE END, 5/8"-11 X 2-1/2", CARBON STEEL/ZINC PLATED	T09C625B50WA2A2	8	STEEL
C7	FOOT, CASE, V-254/423, CARBON STEEL	2540-3400-230	1	STEEL
C8	SCREW, CAP, HEX, 5/8"-11 X 3/4", CARBON STEEL/ZINC PLATED	S01C625750WA2A4	4	STEEL
C9	STUD, DOUBLE END, 3/4"-10 X 3", CARBON STEEL/ZINC PLATED	T09C750C00WA2A2	16	STEEL
C10	NUT, HEX, 3/4"-10, CARBON STEEL/ZINC PLATED	N04C750625WA2A2	16	STEEL
D1	ROTOR/SHAFT, ASM, V-423, A, DUCTILE IRON/CARBON STEEL	4230-4040-121	1	DUCTILE IRON/STEEL
	ROTOR/SHAFT, ASM, V-423, B, DUCTILE IRON/CARBON STEEL	4230-4041-121	1	DUCTILE IRON/STEEL
	ROTOR/SHAFT, ASM, V-423, C, DUCTILE IRON/CARBON STEEL	4230-4042-121	1	DUCTILE IRON/STEEL
D2	BUSHING, ROTATING THRUST, V-423, HARDENED STEEL	4230-4830-370	1	HARDENED ALLOY STEEL
E1	GEAR, IDLER, ASM, G/V-423, DUCTILE IRON/BRONZE	4230-5010-121	1	DUCTILE/BRONZE
E2	GEAR, IDLER, G/V-423, DUCTILE IRON	4230-5100-121	1	DUCTILE
E3	BUSHING, IDLER, G/V-423, BRONZE	4230-5800-320	1	BRONZE
F1	HEAD, ASM, G/V-423, CAST IRON/HARDENED STEEL (INCLUDES F2 THRU F8)	4230-6010-110	1	CAST IRON/STEEL
	HEAD, ASM, JACKETED, G/V-423, CAST IRON/HARDENED STEEL	4230-6030-110	1	CAST IRON/STEEL
F2	HEAD, G/V-423, CAST IRON	4230-6110-110	1	CAST IRON
	HEAD, JACKETED, G/V-423, CAST IRON	4230-6130-110	1	CAST IRON
F3	PIN, IDLER, G/V-423, HARDENED STEEL	4230-6200-231	1	HARDENED STEEL
F4	PLUG, PIPE, 1/8" NPT, CARBON STEEL/ZINC PLATED	PLUG-013NSH-230	1	STEEL
F5	PLUG, PIPE, 1/8" NPT, CARBON STEEL/ZINC PLATED	PLUG-013NSH-230	1	STEEL
F6	GASKET, BRACKET/HEAD, V-254/423, .015, INTERFACE TS-9003	2540-6900-950	2	INTERFACE TS-9003
F7	GASKET, HEAD, V-254/423, .005, HI TEMP GRAPHITE	2540-6901-952	1	GRAPHITE 2010B
F8	NUT, HEX, 5/8"-11, CARBON STEEL/ZINC PLATED	N04C625562WA2A2	8	STEEL
F9	PLUG, PIPE, 1-1/2" NPT, CARBON STEEL/ZINC PLATED	PLUG-150NSH-230	1	STEEL
G1	VALVE, COVER ASM, V-254/423, STAINLESS STEEL/CARBON STEEL (INCLUDES G2, G13 THRU G15)	2540-7000-230	1	STEEL
	VALVE, ASM, V-254/423, 60/70 PSI, CAST IRON (INCLUDES G2 THRU G16)	2540-7001-110	1	CAST IRON
	VALVE, ASM, V-254/423, 100/125 PSI, CAST IRON (INCLUDES G2 THRU G9 and G12 THRU 17)	2540-7002-110	1	CAST IRON
	VALVE, ASM, JACKETED, V-254/423, 60/70 PSI, CAST IRON (INCLUDES G2 THRU G16)	2540-7031-110	1	CAST IRON
	VALVE, ASM, JACKETED, V-254/423, 100/125 PSI, CAST IRON (INCLUDES G2 THRU G9 and G12 THRU 17)	2540-7032-110	1	CAST IRON
G2	VALVE, BODY, V-254/423, CAST IRON	2540-7100-110	1	CAST IRON
	VALVE, BODY, JACKETED, V-254/423, CAST IRON	2540-7130-110	1	CAST IRON
	VALVE, COVER, V-254/423, CARBON STEEL	2540-7101-230	2	STEEL
G3	GASKET, VALVE, BONNET, G1-133/222, V-133/254/423, KLINGERSIL C-4401	1330-7910-951	1	KLINGERSIL C-4401
G4	VALVE, BONNET, G1-133/222, V-133/254/423, CAST IRON	1330-7200-110	1	CAST IRON
G5	GASKET, VALVE, CAP, G1-133/222, V-133/254/423, KLINGERSIL C-4401	1330-7920-951	1	KLINGERSIL C-4401
G6	VALVE, CAP, G1-133/222, V-133/254/423, CAST IRON	1330-7300-110	1	CAST IRON
G7	VALVE, ADJ SCREW, G1-133/222, V-133/254/423, STAINLESS STEEL	1330-7700-255	1	STAINLESS STEEL
G8	VALVE, LOCK NUT, G1-133/222, V-133/254/423, STAINLESS STEEL	1330-7710-255	1	STAINLESS STEEL
G9	VALVE, SPRING GUIDE, G1-133/222, V-133/254/423, STAINLESS STEEL	1330-7500-250	1	STAINLESS STEEL
G11	VALVE, SPRING, G1-133/222 (50/130/150/200 PSI), V-133 (50/130/200 PSI), V-254 (60/140 PSI), V-423 (70 PSI)	1330-7600-250	1	STAINLESS STEEL
G12	VALVE, POPPET, G1-133/222, V-133/254/423, CAST IRON	1330-7400-110	1	CAST IRON
G13	STUD, DOUBLE END, 7/16"-14 X 1-1/2", CARBON STEEL/ZINC PLATED	T09C438A50WA2A2	12	STEEL
G14	NUT, HEX, CENTERLOCK, 7/16"-14, CARBON STEEL/ZINC PLATED	N04C438375WA2A2	12	STEEL
G15	GASKET, VALVE, V-254/423, INTERFACE TS-9003	2540-7900-950	2	INTERFACE TS-9003
G16	PLUG, PIPE, 3/4" NPT, CARBON STEEL/ZINC PLATED	PLUG-075NSH-230	3	STEEL
G17	VALVE, SPRING, G1-133/222 (80/130/150/200), V-133 (80/130/200 PSI), V-254 (100/140 PSI), V-423 (125 PSI)	1330-7601-250	1	STAINLESS STEEL
H1	GLAND, PACKING, V-423, CAST IRON	4230-8230-110	1	CAST IRON
H2	NUT, HEX, 5/8"-11, CARBON STEEL/ZINC PLATED	N04C625562WA2A2	2	STEEL
H3	PACKING, ASM, G1-133/222, V-423, 7 RINGS, PTFE-GRAPHITE	1330-8100-925K	7	PTFE-GRAPHITE
	PACKING, ASM, G1-133/222, V-423, 7 RINGS, WEDGEE PTFE-GRAPHITE	4230-8102-932	7	VARIOUS
H4	WASHER, PACKING RETAINING, G1-133/222, V-423, STAINLESS STEEL	1330-8150-250	1	STAINLESS STEEL
H5	SEAL, TRIPLE LIP SEAL, V-423, SIL CARBIDE/CHEMRAZ/PTFE	4230-8002-929	1	TEFLON/SIC/CHEMRAZ
	SEAL, TRIPLE LIP SEAL, V-423, SIL CARBIDE/AFLAS/PTFE	4230-8002-933	1	TEFLON/SIC/AFLAS

Pump runs, but little product flows.

- Pump speed is too slow.
- Suction piping strainer is too small or obstructed.
- Suction pipe or port is not immersed deep enough within the liquid.
- Piping is improperly installed, permitting air pockets to form in the pump.
- Increased clearances or wear in the pump can cause the pump to deliver an insufficient supply of liquid.
- Air leaks in the suction line.
- Suction losses are too great. The suction lift is too great or the suction line is too small or too long. This can be detected by installing a vacuum gauge directly at the pump suction. The maximum vacuum at the pump suction should never exceed 381 mm-Hg (15 in-Hg). Vaporization caused by higher vacuums will generally result in a reduction of capacity.
- Improper orientation of the head.

Pump runs but no product flows.

- Leaks in suction line or port passage. These can be detected by submerging the pressure line from the discharge side of the pump.
- Direction of shaft rotation is incorrect.
- Relief valve setting is too low. Liquid is discharging through the by-pass port.
- The net-positive suction head available (NPSHa) is lower than required for the vapor pressure of the liquid pumped. Recalculate the NPSHa and redesign piping, if necessary.
- Improper orientation of the head.

Pump operation is erratic or inconsistent.

- Inconsistent suction conditions.
- Leaking suction lines.
- Pump cavitation due to air or vapor in liquid.

Pump is excessively noisy.

- The shaft is worn or bent, causing pump vibration.
- There is an air leak on suction line.
- Cavitation in the pump is occurring.
- The coupling is too close to the pump.
- The coupling is misaligned.

Pump is leaking.

- Retighten all fasteners.

NOTE: Packed gear pumps are designed to leak slightly to prevent excessive heat build-up. An expected leak rate for packed gear pumps is a few drops per minute; more than this may indicate a problem.

CAUTION: When pumping hazardous liquids, a mechanically sealed gear pump is suggested to minimize any potential source of leakage that could result in a hazardous condition.

Pump is drawing too much power.

- The pressure is too high.
- Drive shaft and pump are misaligned.
- Pump shaft is bent.
- Pumped liquid has a higher viscosity than originally accounted for.
- Suction or discharge lines are obstructed or restricted.
- Insufficient horsepower.
- Insufficient end clearance, therefore pump is binding.

Each and every product manufactured by EnviroGear® Pumps is built to meet the highest standards of quality. Every pump is functionally tested to insure integrity of operation.

EnviroGear Pumps warrants that pumps, accessories and parts manufactured or supplied by it to be free from defects in material and workmanship for a period of five (5) years from date of installation or six (6) years from date of manufacture, whichever comes first. Failure due to normal wear, misapplication, or abuse is, of course, excluded from this warranty.

Since the use of EnviroGear Pumps equipment is beyond our control, we cannot guarantee the suitability of any pump or part for a particular application and EnviroGear shall not be liable for any consequential damage or expense arising from the use or misuse of its products on any application. Responsibility is limited solely to replacement or repair of defective EnviroGear products.

All decisions as to the cause of failure are the sole determination of EnviroGear Pumps.

Prior approval must be obtained from EnviroGear for return of any items for warranty consideration and must be accompanied by the appropriate MSDS for the product(s) involved. A Return Goods Tag, obtained from an authorized EnviroGear distributor, must be included with the items which must be shipped freight prepaid.

The foregoing warranty is exclusive and in lieu of all other warranties expressed or implied (whether written or oral) including all implied warranties of merchantability and fitness for any particular purpose. No distributor or other person is authorized to assume any liability or obligation for EnviroGear Pump Company other than expressly provided herein.

PLEASE PRINT OR TYPE, AND EMAIL TO ENVIROGEAR

PUMP INFORMATION			
Item # _____		Serial # _____	
Company Where Purchased _____			
YOUR INFORMATION			
Company Name _____			
Industry _____			
Name _____		Title _____	
Street Address _____			
City _____	State _____	Postal Code _____	Country _____
Telephone _____	Fax _____	Email _____	Web Address _____
Number of pumps in facility? _____		Number of EnviroGear pumps? _____	
Types of pumps in facility (check all that apply): <input type="checkbox"/> Diaphragm <input type="checkbox"/> Centrifugal <input type="checkbox"/> Gear <input type="checkbox"/> Submersible <input type="checkbox"/> Lobe			
<input type="checkbox"/> Other _____			
Media being pumped? _____			
How did you hear of EnviroGear pumps? <input type="checkbox"/> Trade Journal <input type="checkbox"/> Trade Show <input type="checkbox"/> Internet/Email <input type="checkbox"/> Distributor			
<input type="checkbox"/> Other _____			

**ONCE COMPLETE, EMAIL TO
ORDERS@ENVIROGEARPUMP.COM**

Where Innovation Flows



PSG

22069 Van Buren St., Grand Terrace, CA 92313-5607

P: +1 (909) 422-1731 • F: +1 (909) 783-3440

envirogearpump.com

PSG reserves the right to modify the information and illustrations contained in this document without prior notice. This is a non-contractual document. 03-2018

Authorized PSG Representative:

Copyright ©2018, PSG, A Dover Company