



# Fast, effective impact cleaning for small tanks and IBCs

## Alfa Laval GJ 9

### Application

The Alfa Laval GJ 9 is part of the world-renowned Gamajet range of high impact tank cleaning devices. The device offers compact cleaning for small tanks, totes and intermediate bulk containers (IBCs) in both industrial and hygienic applications. With fewer parts and a highly durable design, the Alfa Laval GJ 9 provides superior performance and is the most versatile rotary jet head available. This device readily passes through 76 mm openings and can handle high pressures and temperatures, enabling quick and easy cleaning of small totes/IBCs, tanks, trash carts, and much more. Companies are able to clean in-house and in half the time, saving a substantial amount of time, water, and money.

### Working principle

The Gamajet range of high impact tank cleaning devices combine pressure and flow to create high impact cleaning jets. Cleaning occurs at the point at which the concentrated stream impacts the surface. It is this impact and the tangential force that radiates from that point which blasts contaminants from the surface, scouring the tank interior. In conjunction with this impact, the device is engineered to rotate in a precise, repeatable and reliable, 360° pattern. This full-coverage, global indexing pattern ensures the entire tank interior is cleaned, every time.



### TECHNICAL DATA

Lubricant . . . . . Food grade  
 Max. throw length . . . . . 1.2 - 6 m

### Pressure

Working pressure . . . . . 3 - 70 bar  
 Recommended pressure . . . . . 4 - 40 bar

### Cleaning Pattern

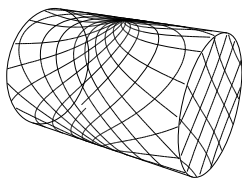

First Cycle

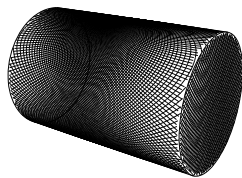

Full Pattern

The above drawings show the cleaning pattern achieved on a cylindrical horizontal vessel. The difference between the first cycle and the full pattern represents the number of additional cycles available to increase the density of the cleaning.

### Certificate

2.1 material certificate



### PHYSICAL DATA

#### Materials

1.4404 (316L), PPS, PTFE, FKM (EPDM and FFKM available).

#### Temperature

Max. working temperature . . . . . 95°C  
 Max. ambient temperature . . . . . 140°C

#### Weight

. . . . . 2.2kg

#### Connections

Standard thread . . . . . ¾" Rp NPT, female/ 1 ¼" camlock  
 Available option . . . . . ¾" BSP, female/ 1 ¼" camlock, 1 ½" tube weld on

#### Options

Electronic rotation sensor to verify 3D coverage.

#### Caution

Do not use for gas evacuation or air dispersion.

Disclaimer: Information in this product data leaflet is intended for general guidance purposes. Specific data for device selection and sizing is available upon request.

**Flow Rate**

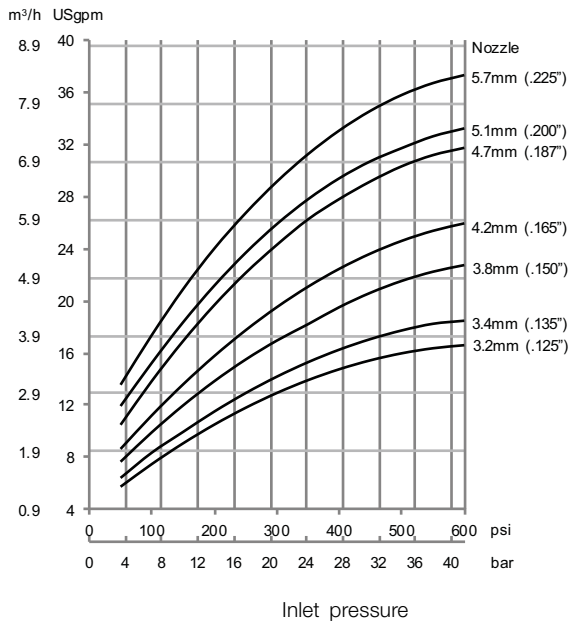

**Impact Throw Length**

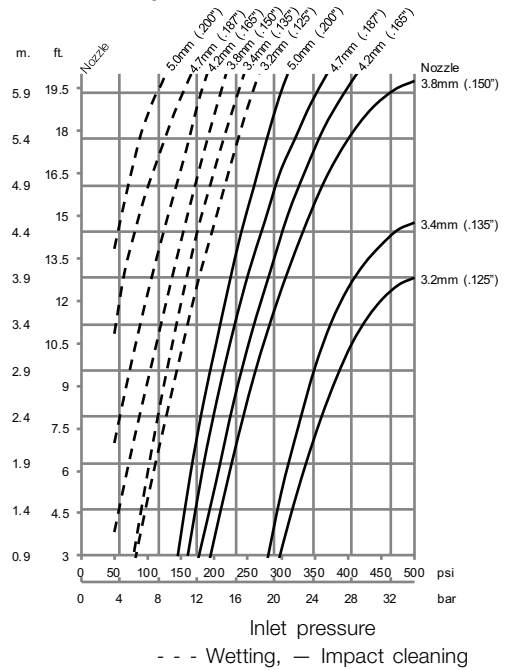

**Dimensions**

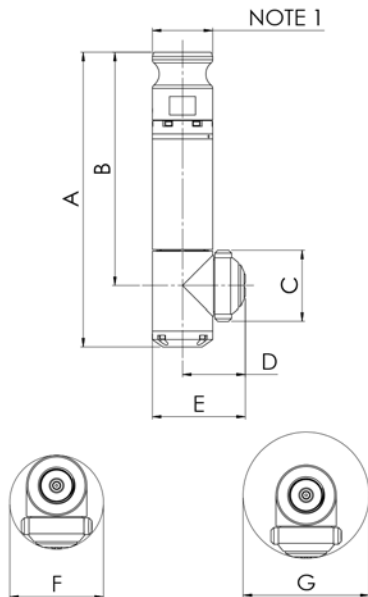

**Cleaning Time**

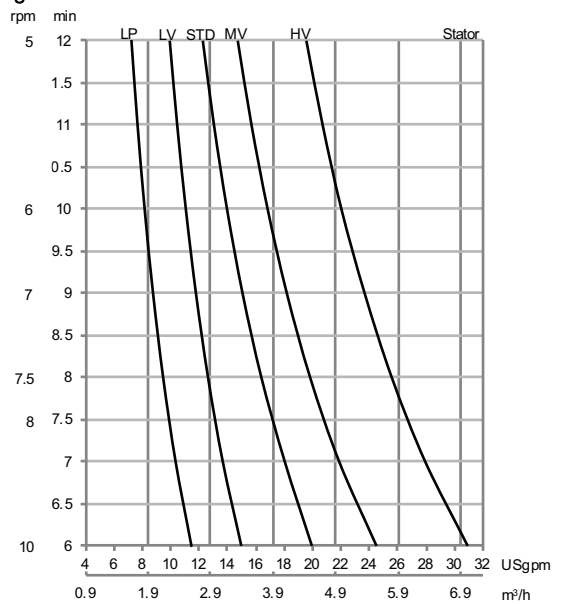

**Dimension (mm)**

A	B	C	D	E	F	G
223	177	54	48	71	72	96

NOTE 1: 3/4" FNPT/1-1/4" CAMLOCK OR 1-1/2" Tri-Clamp

### Standard Design

The choice of nozzle diameters can optimize jet impact length and flow rate at the desired pressure. As standard documentation, the Alfa Laval GJ 9 can be supplied with a "Declaration of Conformity" for material specifications.

### TRAX simulation tool

TRAX is a unique software that simulates how the Alfa Laval GJ 9 performs in a specific tank or vessel. The simulation gives information on wetting intensity, pattern mesh width and cleaning jet velocity. This information is used to determine the best location of the tank cleaning device and the correct combination of flow, time, and pressure to implement.

A TRAX demo containing different cleaning simulations covering a variety of applications can be used as a reference and documentation for tank cleaning applications. The TRAX demo is free and available upon request.

### Wetting Intensity

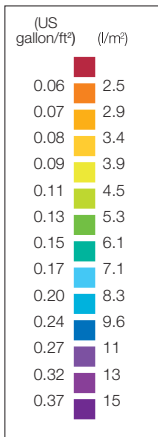

TD 523-208

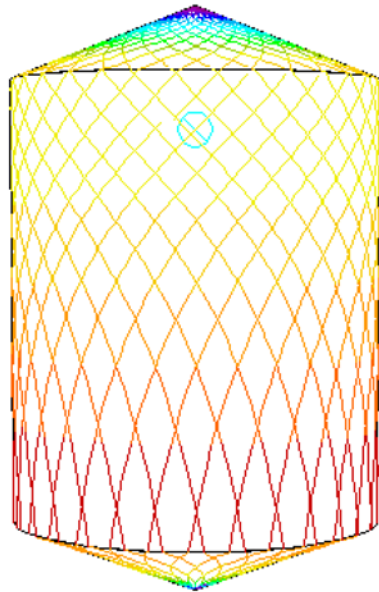

D5.1m, H8.1m, 2xØ4.76mm Time = 2.25 min.

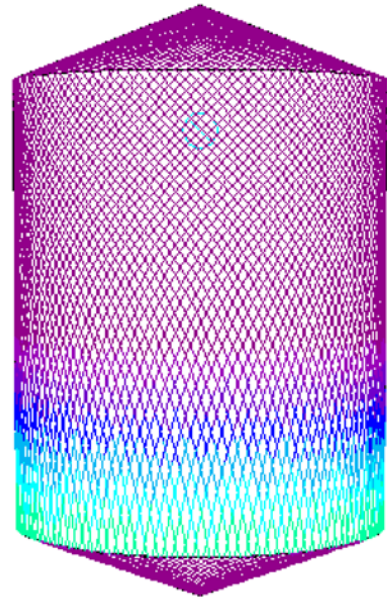

D5.1m , H8.1m, 2xØ4.76mm Time = 9 min.

Alfa Laval reserves the right to change specifications without prior notification. ALFA LAVAL is a trademark registered and owned by Alfa Laval Corporate AB.

ESE03001EN 1015

© Alfa Laval

---

**How to contact Alfa Laval**

Contact details for all countries are continually updated on our website. Please visit [www.alfalaval.com](http://www.alfalaval.com) to access the information direct.