



# Alfa Laval TJ40G Rotary Jet Head

TJ40G best in class in hygienic design

## Application

The TJ40G rotary jet head provides 3D indexed impact cleaning over a defined period. It is automatic and represents a guaranteed means of achieving quality assurance in tank cleaning. Used in breweries, food and dairy processes and many other industries with a strict demand for hygienic tank cleaning. The device is suitable for processing, storage tanks and vessels between 50 and 500 m<sup>3</sup> and industries that require a certain level of hygienic design.

The TJ40G is the best-in-class in hygienic design and tank cleaning performance.

## Working principle

The flow of the cleaning fluid makes the nozzles perform a geared rotation around the vertical and horizontal axes. In the first cycle, the nozzles lay out a coarse pattern on the tank surface. The subsequent cycles continually bisect the coarser pattern into a denser pattern, until a full pattern is reached after 8 cycles.

## Unique features

**Self cleaning** : The TJ40G is designed with numerous of features that ensure self cleaning of the machine, such as directional flow from small jet in the hub that cleans the exterior of the machine.

**Low pressure drop** : A low pressure loss over the machine provides increased cleaning efficiency compared with other tank cleaning machine running at same inlet pressure.

This result in lower cleaning cost as the unit can run at lower pressure/flow compared to other tank cleaning machines.

**Burst cleaning** : The special nozzle design on the TJ40G Burst is designed for fast chemical wetting of the tank, this way of cleaning reduces time, water and chemical. For more information see the datasheet TJ40G Burst

## Available versions

- TJ40G
- TJ40G Burst cleaning
- TJ40G-HD for Heavy Duties

## TECHNICAL DATA

Lubricant: . . . . . Cleaning liquid  
Standard Surface finish: . . . . . Exterior surface finish Ra 0.5µm  
Interior surface finish: . . . . . Ra 0.8µm  
Max throw length (5 bar): . . . . . 21.5 m  
Impact throw length (5 bar): . . . . . 10.5 m

## Pressure

Working pressure: . . . . . 3-12 bar  
Recommended pressure: . . . . . 5-7 bar

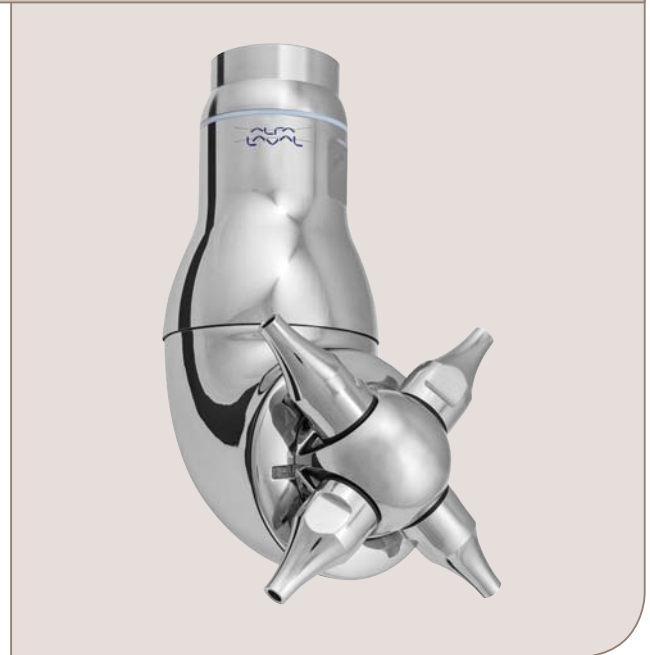

## PHYSICAL DATA

### Materials

AISI 316, SAF 2205, PFA, PEEK, EPDM

### Temperature

Max. working temperature: . . . . . 95°C  
Max. ambient temperature: . . . . . 140°C

**Weight:** . . . . . 6.3 kg

### Options

Rotacheck - Electronic rotation sensor to verify coverage

### Caution

Avoid hard and abrasive particles in the cleaning liquid, as this can cause increased wear and/or damage of internal mechanism. For low amount of particles in the cleaning media a 3mm strainer is recommended for both the TJ40G and TJ40G-HD For high amount of particles in the cleaning media a 0.1mm strainer (TJ40G) and 1mm (TJ40G-HD) is recommended Do not use for gas evacuation and air dispersion

### Certificates

2.2, 3.1 material certificate and ATEX



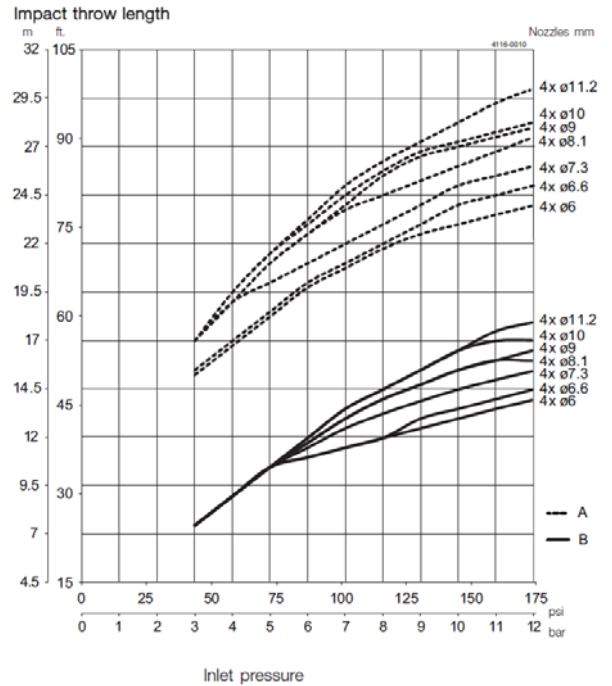
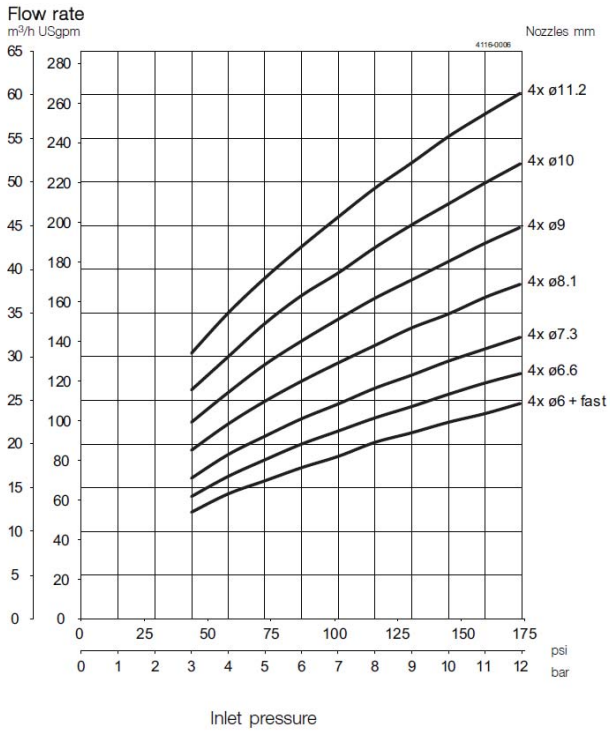

Throw length measured according to tech. specification 93P003

**TJ40G-HD**

	TJ40G	TJ40G Burst	TJ40G-HD	Burst
4xø6 fast	15.8	20.8	17.5	22.5
4xø6	15.8	20.8	17.5	22.5
4xø6,6	18.2	23.2	20.0	25.0
4xø7,3	20.9	25.9	22.5	27.5
4xø8,1	24.9	29.9	26.5	31.5
4xø9	29.1	34.1	31.0	36.0
4xø10	33.8	38.8	35.5	40.5
4xø11	39.0	44.0	41.0	46.0
2xø10	19.2	21.7	20.3	22.8
2xø11	22.4	24.9	23.4	25.9

**Dimensions (mm)**

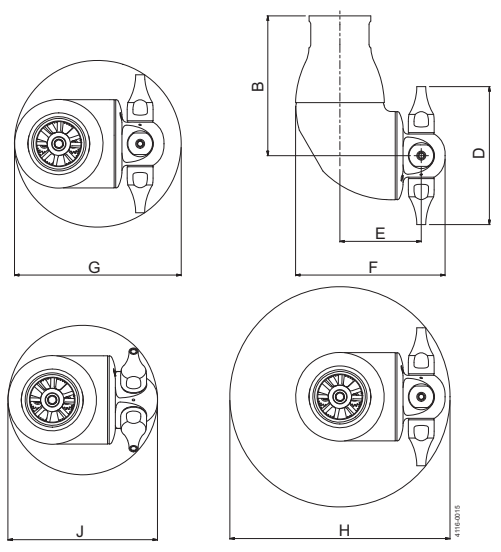

B	D	E	F	G	H	J
156	155	90.8	167	187	246	167

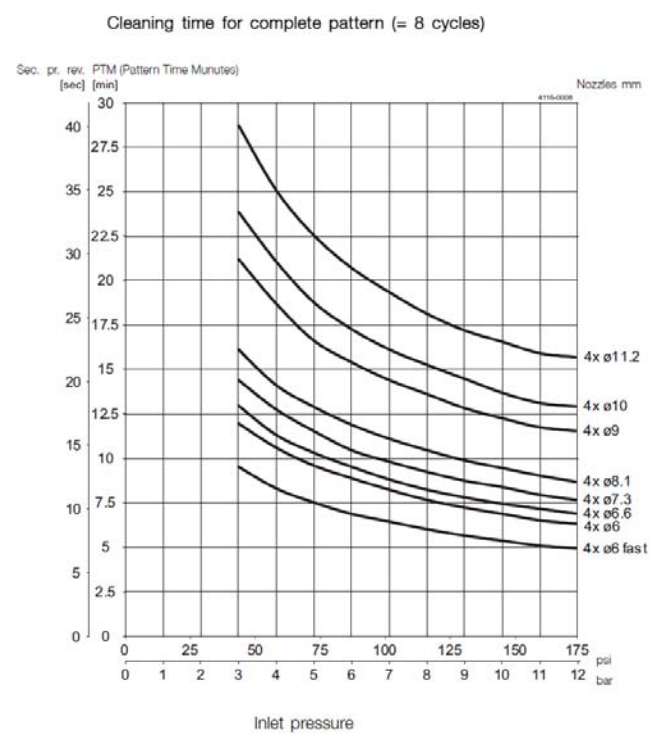

Burst cleaning version has a 20-25% faster complete pattern

## Cleaning Pattern

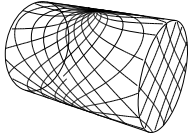

First cycle

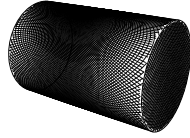

Full pattern

The above drawings show the cleaning pattern achieved on a cylindrical horizontal vessel. The difference between the first cycle and the full pattern represents the number of additional cycles available to increase the density of the cleaning.

## Standard Design

The choice of nozzle diameters can optimize jet impact length and flow rate at the desired pressure.

A Hygienic welding, female or male adaptor is available for following connections :

**Welding adaptors** : 2" / 2½" dairy pipes, 1½" / 2" ISO pipe, DN40 / DN50 / DN65

**Female adaptors** :

1½" BSP, 1½" / 2" NPT

**Male adaptors** : 1½" / 2" BSP, 1½" / 2" NPT

The hygienic design of the TJ40G makes it the best in class for hygienic design. As standard documentation, it can be supplied with a "Declaration of Conformity" for material specification.

## TRAX simulation tool

### Wetting Intensity

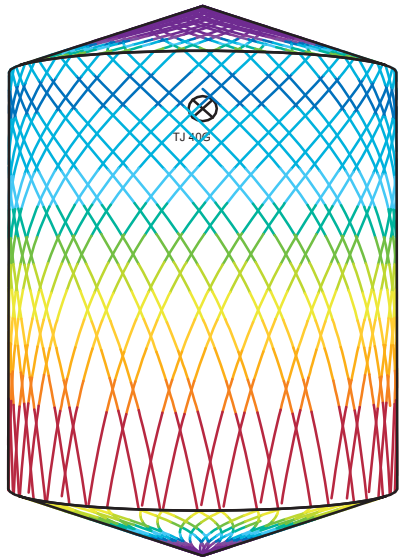
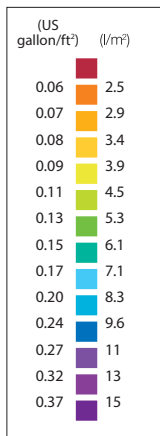

D4.6m H5.5m, Toftejorg TJ40G, 4 x ø7.3 mm, Time = 2 min., Water consumption = 700 l

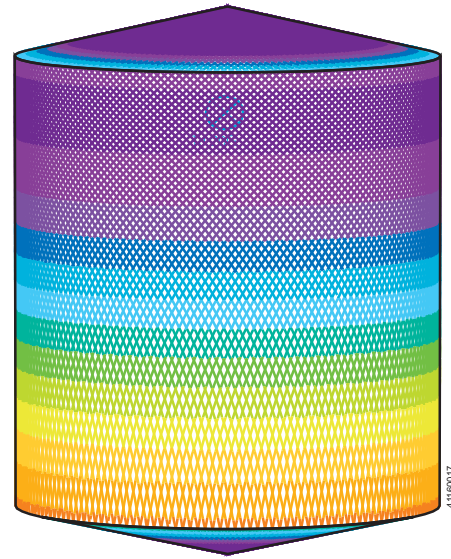

D4.6m H5.5m, Toftejorg TJ40G, 4 x ø7.3 mm, Time = 16 min., Water consumption = 5600 l

Alfa Laval reserves the right to change specifications without prior notification.

---

**How to contact Alfa Laval**

Contact details for all countries  
are continually updated on our website.  
Please visit [www.alfalaval.com](http://www.alfalaval.com) to  
access the information direct.